

FINAL REPORT

Regional Water Plan for Participating  
Municipalities in Atascosa, Frio  
Karnes, and Wilson Counties

JULY 1994

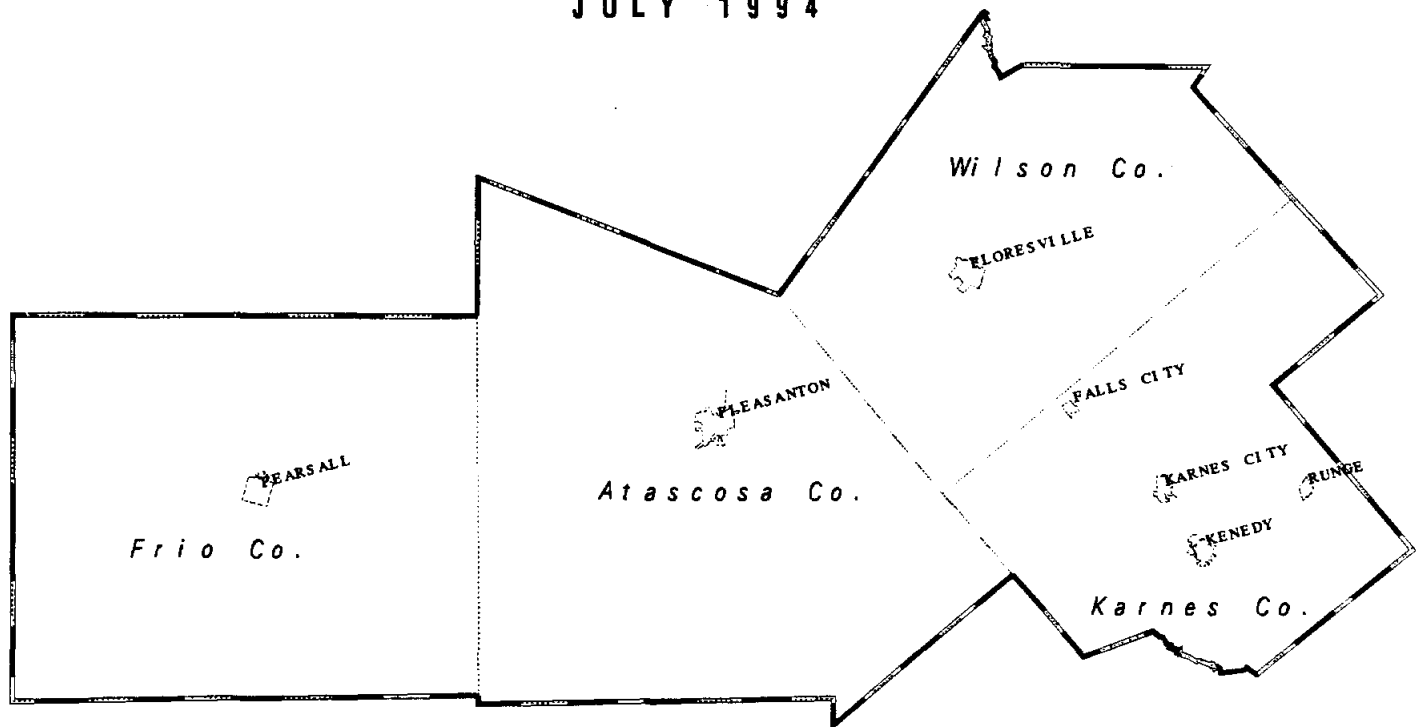

Prepared By



Alamo Area Council of Governments  
118 Broadway, Suite 400  
San Antonio, Texas 78205

**T**  
CE

Thonhoff Consulting Engineers, Inc.  
1301 Capital of Texas Hwy. South  
Suite A-304  
Austin, Texas 78746

Partial Funding Provided By  
The Texas Water Development Board

**REGIONAL WATER PLAN  
FOR PARTICIPATING MUNICIPALITIES  
IN ATASCOSA, FRIO, KARNES, AND WILSON COUNTIES**

**FINAL REPORT  
July 1994**

**Partial Funding for This Project Was Provided By  
The Texas Water Development Board**

**Prepared By:**

**ALAMO AREA COUNCIL OF GOVERNMENTS  
118 Broadway, Suite 400  
San Antonio, Texas 78205**

and

**THONHOFF CONSULTING ENGINEERS, INC.  
1301 Capital of Texas Highway South, Suite A-304  
Austin, Texas 78746  
512/328-6736**

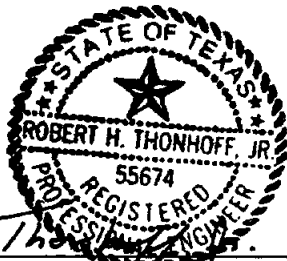

*Robert H. Thonhoff, Jr.*  
**Robert H. Thonhoff, Jr., P.E. 7-27-94**

**REGIONAL WATER PLAN  
FOR PARTICIPATING MUNICIPALITIES  
IN ATASCOSA, FRIO, KARNES AND WILSON COUNTIES**

**TABLE OF CONTENTS**

<b>LIST OF FIGURES</b>	<b>i</b>
<b>LIST OF TABLES</b>	<b>ii</b>
<b>EXECUTIVE SUMMARY</b>	<b>1</b>
<b>1.0 INTRODUCTION</b>	<b>6</b>
1.1 Objective and Scope	6
1.2 Authorization of Report	6
1.3 Acknowledgements	7
<b>2.0 PROJECTIONS OF POPULATION AND WATER USE</b>	<b>9</b>
2.1 Population Projections	9
2.2 Water Conservation and Drought Contingency Plan	9
2.3 Water Use Projections	10
2.3.1 General	10
2.3.2 Per Capita Demands	10
2.3.3 Average Daily Demands	11
2.3.4 Maximum Daily Demands	11
2.3.5 Water Conservation	11
2.4 General Water Use Projections for Four County Area	17
<b>3.0 EXISTING WATER SUPPLIES</b>	<b>19</b>
3.1 Groundwater Resources	19
3.1.1 Wilcox Group	23
3.1.2 Carrizo Sand	24
3.1.3 Queen City	28
3.1.4 Secondary Aquifers	29
3.2 Surface Water Sources	31
<b>4.0 EXISTING WATER SUPPLY FACILITIES</b>	<b>34</b>
4.1 General	34
4.2 City of Falls City	34
4.3 City of Floresville	37
4.4 City of Karnes City	40
4.5 City of Kenedy	43
4.6 City of Pearsall	47
4.7 City of Pleasanton	53
4.8 City of Runge	55
4.9 Other Non-participating Water Purveying Entities	61

**TABLE OF CONTENTS**  
**(Continued)**

<b>5.0 FUTURE WATER SUPPLY NEEDS</b>	<b>68</b>
5.1 Water Supply	<b>68</b>
5.2 Water Supply Facilities	<b>72</b>
<b>6.0 SCREENING OF ALTERNATIVE WATER SUPPLY SOURCES</b>	<b>75</b>
6.1 General	<b>75</b>
6.2 Groundwater	<b>75</b>
6.2.1 Falls City - Karnes County	<b>76</b>
6.2.2 Floresville - Wilson County	<b>77</b>
6.2.3 Karnes City - Karnes County	<b>79</b>
6.2.4 Kenedy - Karnes County	<b>80</b>
6.2.5 Pearsall - Frio County	<b>82</b>
6.2.6 Pleasanton - Atascosa County	<b>84</b>
6.2.7 Runge - Karnes County	<b>85</b>
6.3 Surface Water	<b>87</b>
6.4 Recommended Alternatives for Further Evaluation	<b>88</b>
<b>7.0 EVALUATION OF ALTERNATIVES</b>	<b>91</b>
7.1 General	<b>91</b>
7.2 Autonomous Water Systems	<b>92</b>
7.3 Regional Water Systems	<b>93</b>
7.4 Summary of Analysis	<b>97</b>
<b>8.0 IMPACT OF WATER CONSERVATION</b>	<b>99</b>
8.1 General	<b>99</b>
<b>9.0 ENVIRONMENTAL, SOCIAL AND ECONOMIC ANALYSIS OF STUDY AREA</b>	<b>102</b>
9.1 General	<b>102</b>
9.2 Social and Economic Assessment	<b>102</b>
9.3 Historic and Archaeological Assessment	<b>104</b>
9.4 Ecological Assessment	<b>104</b>
9.4.1 River Basins	<b>104</b>
9.4.2 Wetlands	<b>105</b>
9.4.3 Endangered or Threatened Species	<b>105</b>
9.5 Well Head Protection	<b>109</b>
<b>10.0 IMPLEMENTATION PLAN</b>	<b>111</b>
10.1 Description of the Proposed Plan	<b>111</b>
10.2 Financial Considerations	<b>112</b>
10.3 Cost of Water	<b>112</b>
10.4 Institutional Considerations	<b>113</b>
10.5 Scheduling of Project	<b>116</b>

**REFERENCES**

## LIST OF FIGURES

Figure 1.1-1	AACOG Project Area	8
Figure 3.1-1	Geohydrologic Cross-Section along Geologic Strike Showing Primary Aquifers in the Southern AACOG Region	20
Figure 3.1-2	Geohydrologic Cross-Section along Geologic Dip Showing Primary and Secondary Aquifers in Southern AACOG Region	21
Figure 3.1-3	Extent of Fresh to Slightly Saline Water in the Wilcox Aquifer	25
Figure 3.1-4	Dissolved Solids Content of Water from Selected Wells in the Carrizo Aquifer	27
Figure 3.1-5	Extent of Fresh to Slightly Saline Water in the Queen City Aquifer	30
Figure 3.2-1	Existing and Proposed Surface Water Impoundments near the AACOG Project Area	33
Figure 4.2-1	City of Falls City Water System Schematic	39
Figure 4.3-1	City of Floresville Water System Schematic	42
Figure 4.4-1	City of Karnes City Water System Schematic	45
Figure 4.5-1	City of Kenedy Water System Schematic	49
Figure 4.6-1	City of Pearsall Water System Schematic	52
Figure 4.7-1	City of Pleasanton Water System Schematic	57
Figure 4.8-1	City of Runge Water System Schematic	60
Figure 4.9-1	Water Purveying Entities in Atascosa County	64
Figure 4.9-2	Water Purveying Entities in Frio County	65
Figure 4.9-3	Water Purveying Entities in Karnes County	66
Figure 4.9-4	Water Purveying Entities in Wilson County	67
Figure 7.3-1	Region A Proposed Water System	94
Figure 7.3-2	Region B Proposed Water System	95
Figure 7.3-3	Region C Proposed Water System	96

## LIST OF TABLES

Table 2.1-1	Historical Population for Atascosa, Frio, Karnes, and Wilson Counties	10
Table 2.3-1	Low Population and Water Use Projections	13
Table 2.3-2	High Population and Water Use Projections	14
Table 2.3-3	Low Population and Water Use Projections with Conservation	15
Table 2.3-4	High Population and Water Use Projections with Conservation	16
Table 2.4-1	Population and Water Use Projections for Atascosa, Frio, Karnes, and Wilson Counties	18
Table 3.1-1	Stratigraphic Units and Their Water-bearing Properties in the AACOG Area	22
Table 4.1-1	Groundwater and Well Data on Participating Municipalities in AACOG project area	35
Table 4.1-2	Comparison of General Water Quality of Participating Municipalities	36
Table 4.2-1	City of Falls City Water Supply Facilities Projections	38
Table 4.3-1	City of Floresville Water Supply Facilities Projections	41
Table 4.4-1	City of Karnes City Water Supply Facilities Projections	44
Table 4.5-1	City of Kenedy Water Supply Facilities Projections	48
Table 4.6-1	City of Pearsall Water Supply Facilities Projections	51
Table 4.7-1	City of Pleasanton Water Supply Facilities Projections	56
Table 4.8-1	City of Runge Water Supply Facilities Projections	59
Table 4.9-1	List of All Water Purveying Entities in Atascosa, Frio, Karnes, and Wilson Counties	61
Table 5.1-1	Water Usage of All Water Purveying Entities in AACOG Project Area	69
Table 5.1-2	Additional Water Supply (MGD) Required Based on High Population and Water Use Projection	72
Table 5.2-1	Additional Ground Storage Requirements (Gallons) Based Upon High Population And Water Use Projections	73
Table 5.2-2	Projected Water Facility Replacement Prior to Year 2020	73

**LIST OF TABLES**  
**(continued)**

Table 5.2-3	Estimated New Water Supply and Ground Storage Capacity needed to Maintain TNRCC Rated Capacity Through Design Year 2020	<b>74</b>
Table 6.3-1	Choke Canyon Reservoir Water Rights Holders	<b>87</b>
Table 6.4-1	Water Use Projection for Regional Water Systems	<b>90</b>
Table 7.2-1	Cost of Remaining An Autonomous Water Purveying Entity In 1994 Dollars Through Design Year 2020	<b>93</b>
Table 8.1-1	Percentage of Reduction in Water Usage with Conservation Practices Low Projections	<b>100</b>
Table 8.1-2	Percentage of Reduction in Water Usage with Conservation Practices High Projections	<b>100</b>
Table 9.2-1	Employment In AACOG Project Area	<b>103</b>
Table 9.2-2	Per Capita Income In AACOG Project Area	<b>103</b>
Table 9.4-1	List of Endangered Species Found in AACOG Project Area	<b>107</b>
Table 10.5-1	Regional Water System Project Schedule	<b>116</b>

## EXECUTIVE SUMMARY

This report identifies and evaluates current and future water supply needs for seven participating municipalities in Atascosa, Frio, Karnes, and Wilson Counties. These municipalities include Falls City, Floresville, Karnes City, Kenedy, Pearsall, Pleasanton, and Runge. In addition, the report identifies current and future water supply sources for each participating municipality and presents alternative plans for meeting these needs. The report recommends a plan to provide a Regional Water System to meet the water supply needs of the participating municipalities.

Water needs for each participating municipality were projected for the years 2000, 2010, 2020, and 2040. The study was to cover a thirty year planning period; however, fifty year figures were available and were utilized in most instances to better evaluate alternative water supply sources.

Population projections were developed for each participating municipality as well as for each county in the area of study. High population projections are as follows:

	<u>1990</u>	<u>2020</u>	<u>2040</u>
Falls City	478	547	568
Floresville	5,247	9,228	10,836
Karnes City	2,916	3,338	3,478
Kenedy	3,763	4,304	4,470
Pearsall	6,924	9,786	11,491
Pleasanton	7,678	12,356	14,855
Runge	1,139	1,305	1,344
Atascosa County	30,533	49,394	59,580
Frio County	13,472	19,958	23,628
Karnes County	12,455	13,797	14,207
Wilson County	22,650	41,839	49,583

Water use projections were developed for each participating municipality as well as for each county



in the area of study. High water use projections in MGD based upon the high population projection are tabulated as follows:

	<u>1990</u>	<u>2020</u>	<u>2040</u>
Falls City	0.091	0.115	0.119
Floresville	0.932	1.670	1.961
Karnes City	0.366	0.451	0.470
Kenedy	0.609	0.775	0.804
Pearsall	1.430	2.134	2.505
Pleasanton	1.389	2.211	2.659
Runge	0.146	0.187	0.194
Atascosa County	5.062	8.486	10.175
Frio County	2.718	3.508	4.119
Karnes County	1.952	2.399	2.466
Wilson County	3.343	7.068	8.359

Peak day demand, the demand which must be met by water production facilities, was calculated for each participating municipality. Peak day demands in MGD based upon the high population and water use projections are tabulated as follows:

	<u>1990</u>	<u>2020</u>	<u>2040</u>
Falls City	0.235	0.297	0.307
Floresville	2.209	3.958	4.648
Karnes City	0.761	0.938	0.978
Kenedy	1.133	1.442	1.495
Pearsall	4.519	6.743	7.916
Pleasanton	3.070	4.886	5.876
Runge	0.328	0.416	0.432

Water conservation could reduce these numbers by the following estimated percentage for each participating municipality:

	<u>2020</u>	<u>2040</u>
Falls City	13%	16%
Floresville	14%	16%
Karnes City	15%	19%
Kenedy	13%	16%
Pearsall	12%	15%
Pleasanton	15%	17%
Runge	14%	18%

Existing production facilities are currently adequate for each participating municipality. Water quality is a concern for those entities in central Karnes County. Water quantity loss due to older wells failing is a concern for each participating municipality.

To meet the needs of the seven participating municipalities within the four county AACOG project area, three regional water systems were planned. Region A would serve large portions of Wilson and Karnes County including the participating municipalities of Floresville, Falls City, Karnes City, Kenedy, and Runge, and the non-participating entities of Stockdale, Sunko WSC, SS WSC, Oak Hill WSC, Poth, Three Oaks WSC and El Oso WSC. Region B would serve an area within Atascosa County including the participating municipality of Pleasanton and the non-participating entities of Poteet, Benton City WSC, McCoy WSC, Jourdanton, and Charlotte. Region C would serve the participating municipality of Pearsall and the non-participating entities of Devine, Bigfoot WSC, Moore WSC, and Dilley.

To serve the water supply needs of each region, it was assumed that each entity included in the region could maintain existing production levels. Additional demands would then be supplied through excess capacity of a particular entity or through a regional solution to obtain the "best quality" or "most cost-effective" water.

The projected demand for each region is itemized as follows:

	<u>2020</u>	<u>2040</u>
Region A	6.8 MGD	7.8 MGD
Region B	6.2 MGD	7.4 MGD
Region C	3.9 MGD	4.5 MGD

Groundwater resources are ample to serve the projected consumptive use within each region.

The projected total project cost for each region is itemized as follows:

Region A	\$6.3 Million Dollars
Region B	\$2.4 Million Dollars
Region C	\$4.2 Million Dollars

Implementation of water conservation measures in each region may lower the total project costs about the same percentage as the percentage of water use reduction, or about 12-19%.

Environmental concerns appear negligible because new waterline infrastructure can be constructed within State Highway Rights-of-way.

Implementation of this plan will involve the creation of a regional water system institution in which all participating entities would be a member. Benefits would include:

- \* Increased quality and/or quantity of water supply for those entities in immediate need.
- \* Revenue for those entities able to sell excess water to Regional System.
- \* Greater Component Reliability of Water Supply.
- \* Shared expense in procuring "best quality" and/or most

"cost-effective" water supply.

The project implementation schedule estimates that a regional water system could be in place within a 36 month period.

## **1.0 INTRODUCTION**

### **1.1 OBJECTIVE AND SCOPE**

The purpose of this study and report is to evaluate the water supply currently available to participating municipalities in Atascosa, Frio, Karnes, and Wilson Counties, project future water supply needs by decade through the year 2020, to evaluate water supply alternatives to meet these needs. To better evaluate surface water alternatives, figures for a fifty (50) year projection were also determined and used. This report will present the results of the evaluation of the existing water supply, the population and water use projection for the participating municipalities, discuss water supply alternatives, evaluate selected alternatives, propose the implementation of specific alternatives, and discuss issues related to the proposed alternatives.

The following is a list of the participating municipalities in this study:

1. City of Falls City
2. City of Floresville
3. City of Karnes City
4. City of Kenedy
5. City of Pearsall
6. City of Pleasanton
7. City of Runge

### **1.2 AUTHORIZATION OF REPORT**

This study and report are being partially financed by a planning grant issued to the Alamo Area Council of Governments (AACOG) by the Texas Water Development Board. In addition, each participating municipality contributed financially to support the development of this project. Thonhoff Consulting Engineers, Inc. was authorized by contract with the Alamo Area Council of Governments dated July 1, 1993, to perform this Water System Plan for the participating municipalities in Atascosa, Frio, Karnes, and Wilson Counties.

### 1.3 ACKNOWLEDGEMENTS

The preparation of this report was a joint effort between Thonhoff Consulting Engineers, Inc., and the Alamo Area Council of Governments. R.W. Harden & Associates, Inc., performed as a subconsultant to Thonhoff Consulting Engineers, Inc., and prepared major sections of this report concerning groundwater resources. A project Advisory Board was established consisting of representatives from all participating municipalities and representatives from the San Antonio River Authority, Nueces River Authority, and Evergreen Underground Water District. In addition, the participating municipalities provided base data, information, and resources on a local basis to support the development of this project.

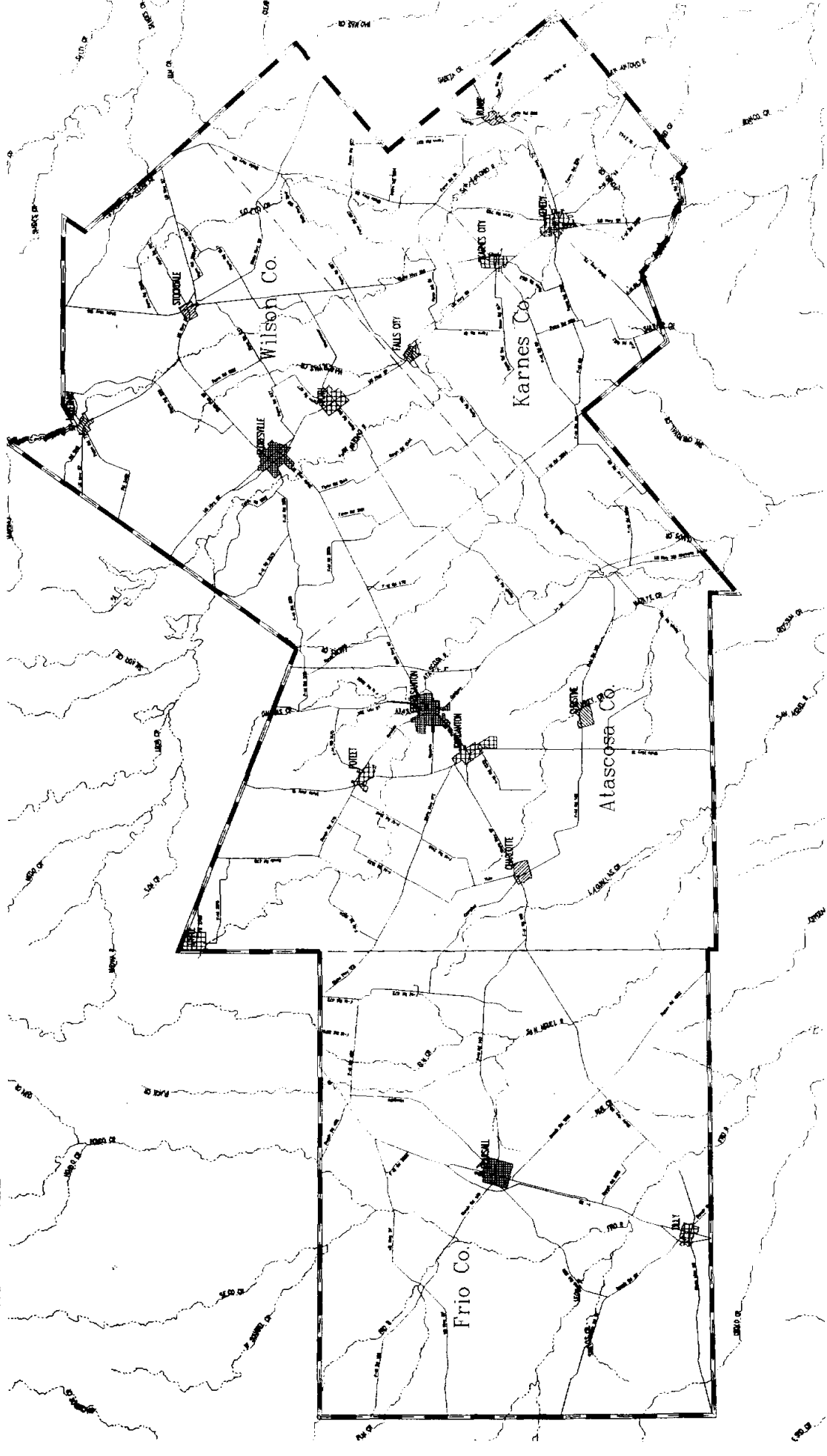

Regional Data Center



Map Scale: 1" = 67 miles

Figure 11-1  
AACOG Project Area  
Map prepared by the Texas A&M University System, Agricultural Experiment Station, Del Rio, Texas

- Map Legend
- ▨ Population < 1000
  - ▩ Population 1000 - 1499
  - ▧ Population 1500 - 5000
  - ▦ Population above 5000
  - Study Area Boundary
  - == Selected Major Roads
  - - - County Line
  - ~ Error or Creek

## **2.0 PROJECTIONS OF POPULATION AND WATER USE**

### **2.1 POPULATION PROJECTIONS**

According to the 1990 Census of the four counties, only Frio and Karnes did not experience growth between 1980 and 1990. Historical population trends for Atascosa, Frio, Karnes, and Wilson counties are included in Table 2.1-1.

The population figures for each of these entities was prepared and maintained by the Texas Water Development Board (TWDB). However, the population projections could only be obtained for the municipalities with over 1000 in population. Because the City of Falls City population falls below this figure it was necessary to develop population figures similar to those developed by TWDB. Initially because Kenedy has similar characteristics to Falls City in economic activity and population types, its percentage of change in population was applied to the 1990 Census figure for Falls City. The water use figures for Falls City were developed based on historical and analytical data provided by TWDB and applied to the population figures.

### **2.2 WATER CONSERVATION AND DROUGHT CONTINGENCY PLAN**

To obtain financial assistance from the TWDB or Water Loan Assistance Fund by a political subdivision, it is necessary that a water conservation and drought contingency plan be developed and implemented. These requirements were set by the 69th Texas Legislature in 1985 by House Bill (HB) 2 and Joint Resolution (HJR) 6. Texas voters approved the amendment to the Texas Constitution implementing HB 2 on November 5, 1985.

Though it was not specifically required for this study, a Water Conservation and Emergency Water Demand Management Plan has been developed as a part of this project. The plan is included in Appendix D of this report.



**TABLE 2.1-1**  
**HISTORICAL POPULATION FOR**  
**ATASCOSA, FRIO, KARNES AND WILSON**  
**COUNTIES**

	<u>ATASCOSA</u>	<u>FRIO</u>	<u>KARNES</u>	<u>WILSON</u>
1930	15,654	9,411	23,316	17,606
1940	19,275	9,207	19,248	17,066
1950	20,048	10,357	17,139	14,672
1960	18,828	10,112	14,995	13,267
1970	18,696	11,159	13,462	13,041
1980	20,055	13,785	13,593	16,756
1990	30,533	13,472	12,455	22,650

Source: U.S. Census Bureau

The implementation of the plan is projected to have an effect on the future water supply requirements. This effect is taken into account by reducing the rate of per capita consumption in the water supply projection.

## **2.3 WATER USE PROJECTIONS**

### **2.3.1 General**

The projected water demands for this study were determined by multiplying population projections by projected per capita demands. Tables 2.3-1 and 2.3-2 present the low and high populations respectively and tabulate resultant water use projections.

### **2.3.2 Per Capita Demands**

Per capita demands were determined by using the TWDB Water Demand projections for each of the municipalities in Atascosa, Frio, Karnes and Wilson Counties and their higher population projections.

Having calculated total use and population, the per capita demands could be calculated by dividing the volume of water by the projected population for each year.

### **2.3.3 Average Daily Demands**

Average daily water demands represent the average daily demand over a period of one year (i.e., annual water use/365 days). This value is considered the base demand for estimating minimum daily, maximum daily, and peak hour demands for water system analyses. The average daily demand also establishes the required capacity of water supply sources. Furthermore, the average daily demand is used to provide a basis for water billing and to evaluate operational costs.

### **2.3.4 Peak Day Water Use**

The peak day water use is defined as the maximum water usage during a 24-hour period during the year. This demand would be expected to occur during the summer months when outdoor water uses are at their peak. This value is used to size raw water pumping facilities, treatment plants, and distribution system high service pumps.

### **2.3.5 Water Conservation**

The projected effects of water conservation are summarized in Tables 2.3-3 and 2.3-4. It is assumed that water conservation in Falls City will result in a 3% reduction of water use by the year 2000, an 8% reduction by the year 2010, 12% by 2020, and 16% by 2040.

In Floresville, the figures increase from 5% in 2000 to 16% in 2040. Karnes City projects the most significant reduction in water usage with conservation practices. Reductions in the year 2000 averaged 4.4% to 5.2% depending on whether high or low water use projections were used. In 2040, Karnes City is projected to reduce its water usage of gallons per day per capita by 19.3% with its low projection and 18.5% in its high projection.

Kenedy and Pearsall showed similar reductions in water usage, savings in the year 2000 averaged between 3.7% and 4.4% and gradually increased to 14.7% to 16.1% in the year 2040. There was

only a slight difference in percentage whether the high or low water use projections were used.

Pleasanton showed a 5% reduction in the year 2000 and gradually reduced further to 10% in 2010, 14.5% in 2020, 15.6% in 2030 and 16.8% in 2040.

Runge also may reduce water use through conservation practices projecting 4.9% in the year 2000, 9.7% in 2010, 13.9% in 2020, and 16% and 18.1% respectively in 2030 and 2040.

TABLE 2.3-1

LOW POPULATION AND WATER USE PROJECTIONS

YEAR	FALLS CITY	FLORES VILLE	KARNES CITY	KENEDY	PEARSALL	PLEAS ANTON	RUNGE
<u>PROJECTED GALLONS PER DAY PER CAPITA</u>							
1990	190	178	126	162	207	181	129
2000	210	181	135	180	218	179	144
2010	210	181	135	180	218	179	144
2020	210	181	135	180	218	179	144
2030	210	181	135	180	218	179	144
2040	210	181	135	180	218	179	144
<u>PROJECTED POPULATION</u>							
1990	478	5247	2916	3763	6924	7678	1139
2000	484	6470	2927	3817	7317	9082	1190
2010	499	7637	3020	3926	8724	10249	1216
2020	507	8367	3073	3989	9645	11172	1251
2030	518	8939	3145	4075	10718	12052	1251
2040	525	9354	3173	4110	11000	12353	1259
<u>PROJECTED WATER USE IN MGD</u>							
1990	0.091	0.932	0.366	0.609	1.430	1.389	0.146
2000	0.102	1.171	0.395	0.687	1.595	1.626	0.171
2010	0.105	1.382	0.408	0.707	1.902	1.835	0.174
2020	0.106	1.514	0.415	0.718	2.102	2.000	0.178
2030	0.109	1.618	0.425	0.734	2.336	2.157	0.180
2040	0.110	1.693	0.429	0.740	2.398	2.211	0.181
<u>PROJECTED PEAK DAY WATER USE IN MGD</u>							
<u>PEAK DAY TO AVG DAY RATIO</u>							
	2.58	2.37	2.08	1.86	3.16	2.21	2.24
1990	0.235	2.209	0.761	1.133	4.519	3.070	0.328
2000	0.268	2.775	0.821	1.278	5.040	3.594	0.383
2010	0.271	3.275	0.847	1.315	6.010	4.055	0.390
2020	0.274	3.588	0.863	1.336	6.642	4.420	0.399
2030	0.281	3.835	0.884	1.365	7.318	4.767	0.403
2040	0.284	4.012	0.892	1.376	7.575	4.886	0.405

**TABLE 2.3-2  
HIGH POPULATION AND WATER USE PROJECTIONS**

YEAR	FALLS CITY	FLORES VILLE	KARNES CITY	KENEDY	PEARSALL	PLEAS ANTON	RUNGE
<u>PROJECTED GALLONS PER DAY PER CAPITA</u>							
1990	190	178	126	162	207	181	129
2000	210	181	135	180	218	179	144
2010	210	181	135	180	218	179	144
2020	210	181	135	180	218	179	144
2030	210	181	135	180	218	179	144
2040	210	181	135	180	218	179	144
<u>PROJECTED POPULATION</u>							
1990	478	5247	2916	3763	6924	7678	1139
2000	512	6785	3107	4029	7337	9507	1241
2010	535	8270	3259	4210	8782	11059	1283
2020	547	9228	3338	4304	9786	12356	1305
2030	561	10070	3436	4420	10982	13604	1333
2040	568	10836	3478	4470	11491	14855	1344
<u>PROJECTED WATER USE IN MGD</u>							
1990	0.091	0.932	0.366	0.609	1.430	1.389	0.146
2000	0.108	1.228	0.420	0.725	1.600	1.702	0.179
2010	0.112	1.497	0.440	0.758	1.914	1.979	0.185
2020	0.115	1.670	0.451	0.775	2.134	2.211	0.187
2030	0.118	1.823	0.464	0.795	2.394	2.435	0.192
2040	0.119	1.961	0.470	0.804	2.505	2.659	0.194
<u>PROJECTED PEAK DAY WATER USE IN MGD</u>							
<u>PEAK DAY TO AVG DAY RATIO</u>							
	2.58	2.37	2.08	1.86	3.16	2.21	2.24
1990	0.235	2.209	0.761	1.133	4.519	3.070	0.328
2000	0.235	2.209	0.761	1.133	4.519	3.070	0.399
2010	0.289	3.548	0.915	1.410	6.048	4.374	0.414
2020	0.297	3.958	0.938	1.442	6.743	4.886	0.419
2030	0.304	4.321	0.965	1.479	7.565	5.381	0.429
2040	0.307	4.648	0.978	1.495	7.916	5.876	0.432

TABLE 2.3-3

LOW POPULATION AND  
WATER USE PROJECTIONS WITH CONSERVATION

YEAR	FALLS CITY	FLORES VILLE	KARNES CITY	KENEDY	PEARSALL	PLEAS ANTON	RUNGE
<u>PROJECTED GALLONS PER DAY PER CAPITA</u>							
1990	190	178	126	162	207	181	129
2000	203	172	129	173	210	170	137
2010	193	163	122	165	200	161	130
2020	185	156	115	157	191	154	124
2030	181	154	112	154	189	151	121
2040	177	152	109	151	186	149	118
<u>PROJECTED POPULATION</u>							
1990	478	5247	2916	3763	6924	7678	1139
2000	484	6470	2927	3817	7317	9082	1190
2010	499	7637	3020	1926	8724	10249	1216
2020	507	8367	3073	3989	9645	11172	1231
2030	518	89390	3145	4075	10718	12052	1251
2040	525	93546	3173	4110	11000	12353	1259
<u>PROJECTED WATER USE IN MGD</u>							
1990	0.091	0.932	0.366	0.609	1.430	1.389	0.146
2000	0.098	1.113	0.378	0.661	1.536	1.544	0.163
2010	0.097	1.244	0.369	0.648	1.744	1.650	0.158
2020	0.094	1.305	0.354	0.627	1.843	1.720	0.153
2030	0.094	1.377	0.353	0.628	2.026	1.819	0.152
2040	0.093	1.422	0.345	0.620	2.046	1.841	0.148
<u>PROJECTED PEAK DAY WATER USE IN MGD</u>							
<u>PEAK DAY TO AVG DAY RATIO</u>							
	2.58	2.37	2.08	1.86	3.16	2.21	2.24
1990	0.235	2.209	0.761	1.133	4.519	3.070	0.328
2000	0.253	2.638	0.785	1.230	4.855	3.412	0.366
2010	0.249	2.948	0.767	1.205	5.512	3.647	0.354
2020	0.242	3.093	0.735	1.166	5.823	3.801	0.342
2030	0.242	3.264	0.733	1.168	6.401	4.020	0.340
2040	0.239	3.370	0.719	1.153	6.466	4.069	0.332

TABLE 2.3-4

HIGH POPULATION AND  
WATER USE PROJECTIONS WITH CONSERVATION

YEAR	FALLS CITY	FLORES VILLE	KARNES CITY	KENEDY	PEARSALL	PLEAS ANTON	RUNGE
<u>PROJECTED GALLONS PER DAY PER CAPITA</u>							
1990	190	178	126	162	206	181	129
2000	199	172	128	172	209	170	137
2010	190	163	122	164	199	161	130
2020	183	156	115	157	191	153	124
2030	180	154	112	154	189	151	121
2040	176	152	110	151	186	149	478
<u>PROJECTED POPULATION</u>							
1990	478	5247	2916	3763	6924	7678	1139
2000	512	6785	3107	4029	7337	9507	1241
2010	535	8270	3259	4210	8782	11059	1283
2020	547	9228	3338	4304	9786	12356	1305
2030	561	10070	3436	4420	10982	13604	1333
2040	568	10836	3478	4470	11491	14855	1344
<u>PROJECTED WATER USE IN MGD</u>							
1990	0.091	0.932	0.366	0.609	1.430	1.389	0.146
2000	0.102	1.167	0.397	0.693	1.534	1.616	0.170
2010	0.102	1.348	0.397	0.690	1.748	1.780	0.167
2020	0.100	1.440	0.384	0.676	1.869	1.891	0.162
2030	0.101	1.551	0.385	0.680	2.076	2.054	0.162
2040	0.100	1.647	0.383	0.675	2.137	2.213	0.159
<u>PROJECTED PEAK DAY WATER USE IN MGD</u>							
<u>PEAK DAY TO AVG DAY RATIO</u>							
	2.58	2.37	2.08	1.86	3.16	2.21	2.24
1990	0.235	2.209	0.761	1.133	4.519	3.070	0.328
2000	0.263	2.766	0.826	1.289	4.847	3.571	0.380
2010	0.263	3.195	0.826	1.283	5.524	3.934	0.374
2020	0.258	3.413	0.799	1.257	5.906	4.179	0.363
2030	0.261	3.676	0.801	1.264	6.560	4.539	0.363
2040	0.258	3.903	0.797	1.256	6.753	4.891	0.356

## **2.4 GENERAL WATER USE PROJECTIONS FOR FOUR COUNTY AREA**

Water use projection for each of the four counties, Atascosa, Frio, Karnes, and Wilson are included in the Table 2.4-1. These projections include the total water use for the participating and non-participating entities of this study. This general overview of each of the counties demonstrates the need for continuing shared water studies conducted for multiple county areas.



**TABLE 2.4-1**

**POPULATION AND WATER USE PROJECTIONS  
FOR ATASCOSA, FRIO, KARNES AND WILSON COUNTIES**

	ATASCOSA	FRIO	KARNES	WILSON
<b>LOW POPULATION PROJECTION</b>				
1990	30,533	13,472	12,455	22,650
2000	36,053	15,730	12,588	28,547
2010	40,810	16,998	12,860	34,168
2020	44,574	18,157	13,016	37,687
2030	48,163	19,420	13,228	40,443
2040	49,434	20,740	13,312	42,443
<b>LOW PROJECTED WATER USE (MGD)</b>				
1990	5.061	2.718	1.952	3.43
2000	6.285	3.158	2.200	4.865
2010	7.101	3.481	2.243	5.797
2020	7.745	3.734	2.269	6.384
2030	8.362	4.016	2.305	6.848
2040	8.569	4.233	2.318	7.181
<b>HIGH POPULATION PROJECTION</b>				
1990	30,535	13,472	12,455	22,650
2000	37,785	16,331	13,116	30,064
2010	44,108	18,307	13,564	37,221
2020	49,394	19,958	13,797	41,839
2030	54,480	13,797	14,085	45,890
2040	59,580	23,628	14,207	49,583
<b>HIGH PROJECTED WATER USE (MGD)</b>				
1990	5.062	2.718	1.952	3.343
2000	6.551	2.848	2.285	5.115
2010	7.606	3.217	2.359	6.299
2020	8.486	3.508	2.399	7.068
2030	9.335	3.825	2.445	7.745
2040	10.175	4.119	2.466	8.359

### **3.0 EXISTING WATER SUPPLIES**

#### **3.1 GROUNDWATER RESOURCES**

Abundant groundwater resources have provided water for public supply, domestic, livestock, and irrigation purposes throughout the project area since before 1900. The vast majority of groundwater is produced for irrigation purposes in the area, and groundwater provides essentially all of the public supply water to cities in the area.

Several aquifers are present underlying all or parts of the counties included. The aquifers included in this report supply water to one or more of the participating municipalities included in the evaluation. The geologic units that form primary aquifers are the Wilcox Group, the Carrizo Sand, and the Queen City Sand. These units provide, or are capable of providing large quantities of water in most of the area delineated. In the eastern portion of the area, the less extensive Catahoula and Oakville Sandstone aquifers provide water to municipalities. Table 3.1-1 provides names and descriptions of the stratigraphic units present in the area.

All of the geologic units forming the aquifers in the area crop out trending generally east-west in the western portion of the area to slightly northeast southwest in eastern parts of the area. The strata generally dip southward in the western part of the area, and southeastward in eastern parts of the area. Some normal faulting occurs in the area, displacing units by up to about 400 feet. Figures 3.1-1 and 3.1-2 provide general cross-sections along geologic strike and dip, respectively.

Each of the aquifers has generally produced the most suitable drinking water in or near its outcrop, which is where recharge occurs. Water quality tends to deteriorate in the down dip direction.

Aquifers supplying water to the municipalities or areas considered in this report are generally described and evaluated below. Evaluations are based on general knowledge of the aquifers, and on cursory investigations of available information. Each aquifer is described in terms of geologic character, structure, hydraulic characteristics and productivity, water quality, historical development, and potential future development.

Figure 3.1-1

Geohydrologic Cross-Section  
 Along Geologic Strike  
 Showing Primary Aquifers  
 in the southern AACOG Region

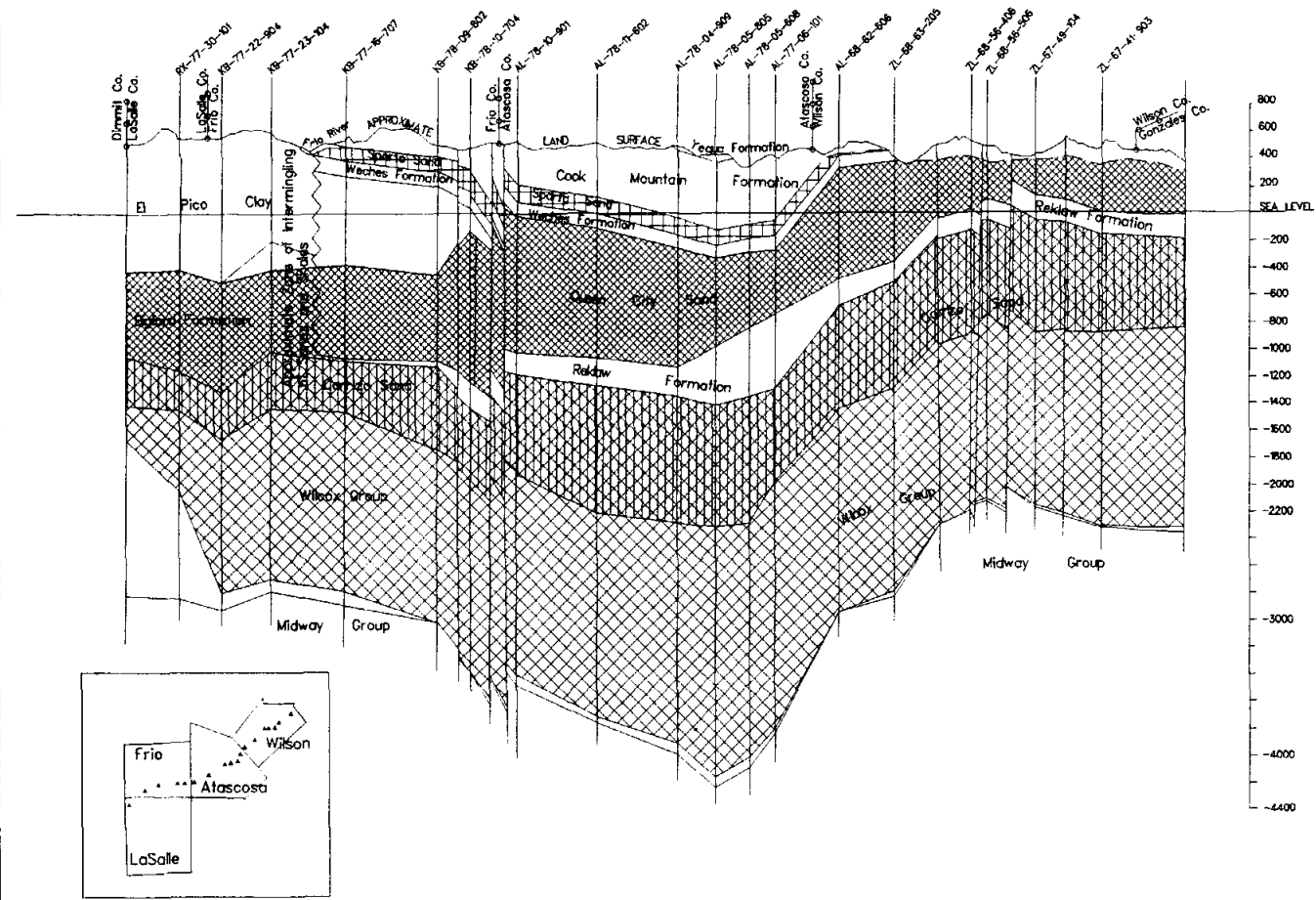

- Legend
- Sparta-Laredo
  - Queen City-Bigford
  - Carrizo
  - Wilcox

Source: Texas Water Development Board  
 Report 210, Vol. 1

Regional Data Center

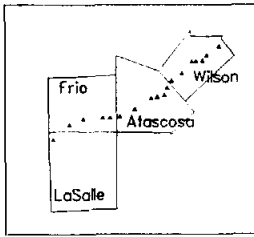

INSET MAP SHOWING GENERAL LOCATION OF WELLS



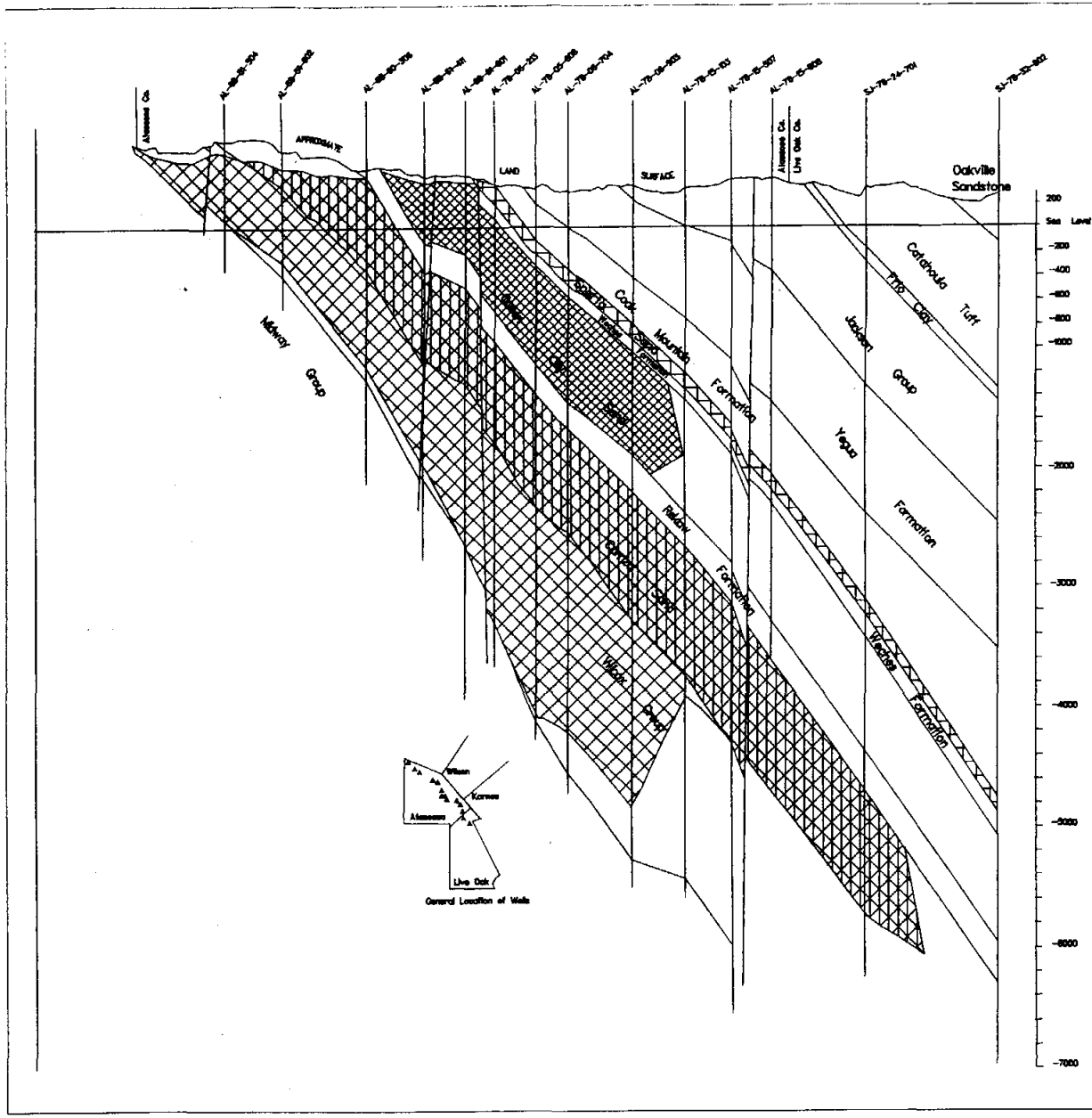

Figure 3.1-2

Geohydrologic Cross-Section Along Geologic Dip Showing Primary and Secondary Aquifers in the southern AACOG Region

Legend

- Sparta-Laredo
- ▨ Queen City-Bigford
- ▩ Carrizo
- ▧ Wilcox

Source: Texas Water Development Board Report 210, Volume 1

Regional Data Center



TABLE 3.1-1  
STRATIGRAPHIC UNITS AND THEIR WATER-BEARING PROPERTIES IN THE AACOG AREA

System	Series	Group	Stratigraphic Unit	Approx. Maximum Thickness (feet)	Character of Formation	Water-Bearing Properties
Quaternary	Recent		Alluvium	48	Clay, silt, sand, and gravel.	Yields small supplies of water to a few domestic and stock wells. Large yields may be obtained locally.
Tertiary	Miocene		Oakville Sandstone	950 ±	Cross-bedded sand and sandstone containing interbedded sandy, ashy, or bentonitic clay.	Yields small to large supplies of water to municipal and irrigation wells.
Tertiary	Miocene ?		Catahoula Tuff	1700 ±	Predominantly tuff, tuffaceous clay, and sandy clay containing sand and sandstone lenses.	Yields small to large supplies of water.
Tertiary	Oligocene ?		Frio Clay	200 ±	Predominantly clay with a little sand and sandy clay.	Not known to yield water to wells in study area.
Tertiary	Eocene		Jackson Group	1700 ±	Sand clay, silt and volcanic ash.	Not known to yield water to wells in study area. Electric logs indicate that the unit contains only saline water in area.
Tertiary	Eocene	Claiborne	Yegua Formation	700-1000+	Clay, silt with interbedded thin lignites and sandstones. Some minor beds of limestone and oyster shells are found.	Yields small quantities of slightly to moderately saline water to wells in the outcrop area.
Tertiary	Eocene	Claiborne	Cook Mountain Formation	400-500	Fossiliferous clay and shale. Some interbedded sandstone and limestone.	Yields small quantities of slightly to moderately saline water to wells.
Tertiary	Eocene	Claiborne	Sparta Sand	40-200	Medium to fine sand. Some interbedded clay.	Yields small to moderate quantities of fresh to moderately saline water to wells.
Tertiary	Eocene	Claiborne	Weches Formation	50-200	Fossiliferous, glauconitic shale and sand.	Not known to yield water to wells.
Tertiary	Eocene	Claiborne	Queen City Sand	500-1400	Marine, medium to fine sand with interbedded clay and shale.	Yields small to moderate quantities of fresh to slightly saline water to wells.
Tertiary	Eocene	Claiborne	Recklaw Formation	200-400	Clay with interbedded glauconitic sand.	Yields small quantities of slightly to moderately saline water to wells in or near the outcrop.
Tertiary	Eocene	Claiborne	Carrizo Sand	150-2000	Coarse to fine sand, massive, cross-bedded with a few partings of carbonaceous clay.	Principal aquifer in the report area. Yields moderate to large quantities of fresh to slightly saline water to wells.
Tertiary	Eocene	Wilcox		0-2800	Interbedded sand, clay and silt with discontinuous beds of lignite. The shale and clay sometimes contain gypsum.	Yields small to moderate quantities of fresh to slightly saline water to wells in the northern and western parts of the report area.

Notes: Yield, in gallons per minute: small, less than 50; moderate, 50 to 500; large, over 500.  
Salinity (total dissolved solids), in mg/L: fresh, less than 1,000; slightly saline, 1,000 to 3,000; moderately saline, 3,000 to 10,000; very saline, 10,000 to 35,000; brine, over 35,000

Sources: Texas Water Commission Bulletin No. 6518  
Texas Water Development Board Report 210, Volume

Based on historical information and on projected water-usage demands consistent with past pumpage increases and normally accepted growth predictors, the aquifers evaluated can likely continue to supply abundant water in the project area for many years. Even unexpected and unlikely large increases in ground-water pumpage would not threaten the capability of these aquifers to meet municipal water supply production demand. However, future groundwater supply decisions for municipalities should be based on site specific evaluations.

### **3.1.1 Wilcox Group**

Stratigraphic units of the Wilcox Group form major aquifers in southern and east-central Texas. In the project area, the Wilcox is mapped as an undifferentiated unit, while east and north of the area, the Wilcox is divided into three distinct formations. In the project area, the upper section of the Wilcox generally contains massive sand beds, while the middle and lower portions consist of layers of sand and clay, with some lignite.

The Wilcox crops out slightly northward and northwestward of Atascosa, Karnes, Frio, and Wilson counties and is only present at the surface in the study area in the northern most part of Wilson and Atascosa Counties. The strike of the outcrop is generally east-west near Frio and Atascosa Counties, but changes to slightly northeast-southwest near Wilson County. The Wilcox dips southward in the updip portions of Frio County, and southeastward throughout the rest of the area. The amount of dip ranges from slightly less than 100 feet per mile to over 150 feet per mile. The top of the Wilcox is about 1,700 to 1,800 feet below land surface near Pearsall in Frio County, and near Floresville in Wilson County. Near Pleasanton in Atascosa County, the Wilcox is about 2,300 to 2,400 feet deep. Southeastward, the Wilcox is deeper; about 3,500 to 4,000 feet near Falls City (Karnes County) and over 5,000 feet deep in south central Karnes County.

The sandy portions of the Wilcox can produce significant quantities of water to wells. Wilcox transmissivity values in the study area are not available; however, in the downdip artesian portions of the aquifer, well yields can be large because pumps can be set deep below the static water level. Recorded pumping rates range from 100 to 1,900 gpm in the area.

The Wilcox is not utilized heavily in the area due to its depth and water quality. Water meeting

drinking water standards is generally only found in updip portions of the Wilcox, reasonably near the outcrop. Records show that suitable drinking water has been produced only as far down dip as northern Atascosa and Wilson Counties. Wilcox water becomes more mineralized down dip. The reported approximate down dip limit of slightly saline water is shown in Figure 3.1-3 (total dissolved solids (TDS) concentrations of less than 3,000 mg/L). Total dissolved solids concentrations of 500 mg/L are recorded as far down dip as central Atascosa and Wilson Counties. Some wells in these areas are completed in both the Wilcox and overlying Carrizo and produce suitable drinking water.

In the study area, Wilcox groundwater production is relatively small and is used for domestic, irrigation, livestock and public supply purposes generally only in updip portions of the aquifer. Down dip, the water is utilized for some industrial purposes. Water-level declines throughout the years have been very slight due to the lack of extensive pumpage.

Based on aquifer characteristics, deep potential pump settings due to the depth of the aquifer, and shallow artesian static water levels, large pumping rates are obtainable in Wilcox wells in the project area. Even if large water level declines occur, which is unlikely, the Wilcox could provide abundant water in the area for many years.



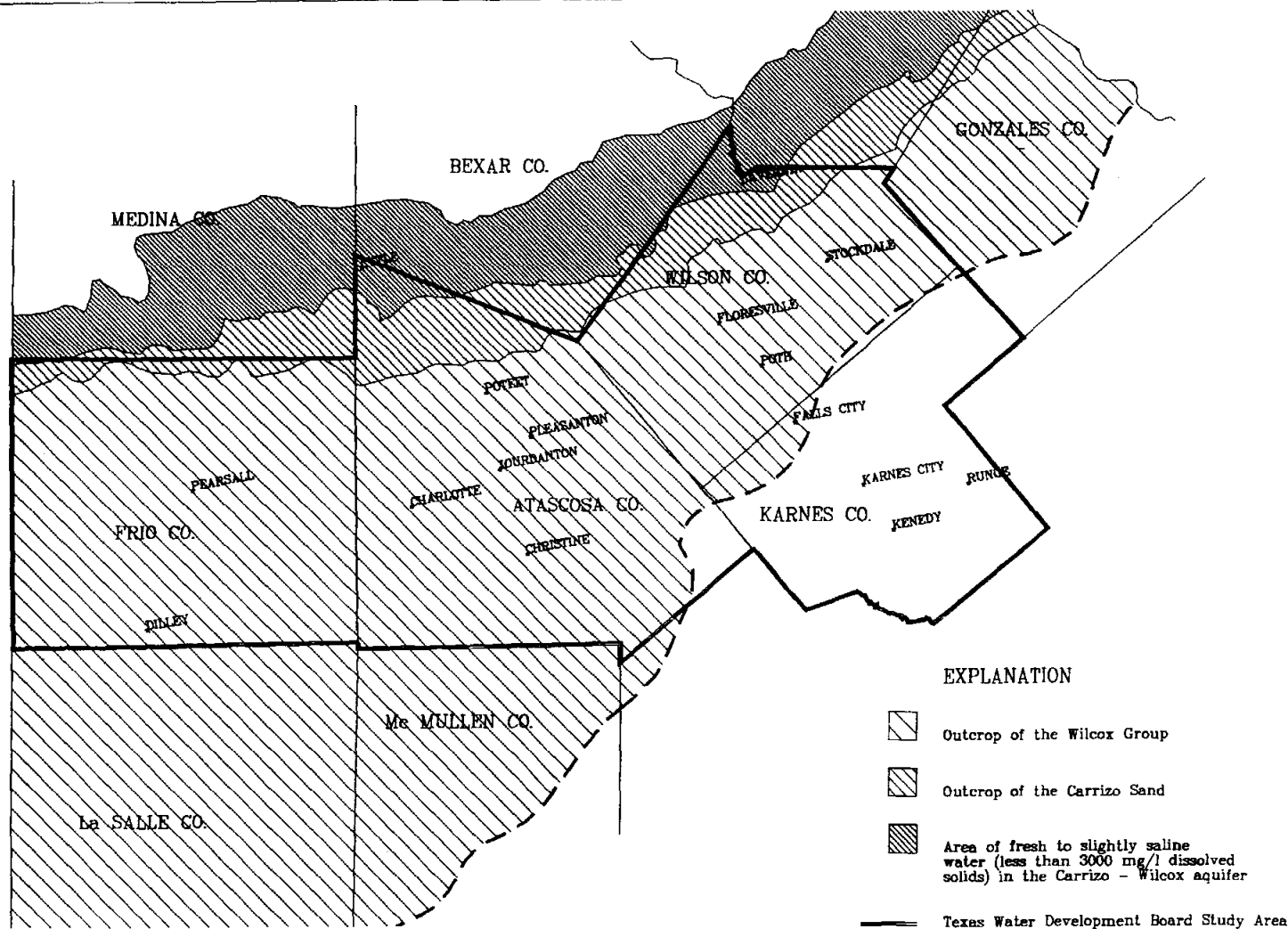

Wilcox groundwater production in the project area is primarily limited by water-quality. However, in some parts of the outlined area, Wilcox water is suitable for public supply. In addition, some wells completed in both the Wilcox and Carrizo Aquifers supply suitable drinking water. The most suitable areas for production of suitable water from the Wilcox are in Atascosa and Wilson Counties. However, improving treatment technologies could be used to allow the Wilcox to be a viable and important future source of water in much of the project area.

### **3.1.2 Carrizo Sand**

The Carrizo Sand forms the most prolific and developed aquifer in the project area. In some instances, the lower Carrizo is difficult to distinguish from the upper Wilcox, and some reports combine the two units into the Carrizo-Wilcox Aquifer. In this area, water-quality differences emphasize the distinction between the two aquifers, as the Carrizo Sands are more permeable and usually contain significantly better quality water than the Wilcox.



EXPLANATION

-  Outcrop of the Wilcox Group
-  Outcrop of the Carrizo Sand
-  Area of fresh to slightly saline water (less than 3000 mg/l dissolved solids) in the Carrizo - Wilcox aquifer
-  Texas Water Development Board Study Area
-  Approx. downdip limit of fresh to slightly saline water in the Wilcox group

Regional Data Center



Map Scale : 1" = 12.4 miles  
 Map produced by Alamo Area Council of Governments.  
 Source : Texas Water Development Board Report 210, Vol. 1

Figure 3.1-3  
 Extent of Fresh to Slightly Saline Water in the Wilcox Aquifer



The Carrizo Sand contains primarily very permeable, massive, medium-grained sands, and ranges in thickness from about 150 feet to 1,200 feet. The Carrizo is approximately 600 to 800 feet thick near Pearsall, Pleasanton and Floresville, and is thickest near Falls City at approximately 1000 feet. The Carrizo is about 700 feet thick near Runge and Kenedy.

The outcrop of the Carrizo is essentially parallel to the Wilcox outcrop, extending along the northern boundary of Frio County, across northern Atascosa County, and along the northwestern boundary of Wilson County. The average dip of the Carrizo is approximately the same as for the Wilcox, ranging from about 100 to 150 feet per mile. The depth to the top of the Carrizo is about 700 to 900 feet at Floresville, about 1,100 to 1,200 feet at Pearsall, and about 1,300 to 1,400 feet at Pleasanton. The Carrizo is about 2,500 to 2,800 feet at Falls City, about 4,500 to 5,000 feet deep at Karnes City, and over 6,000 feet deep at Kenedy and Runge.

The Carrizo Aquifer is capable of producing large quantities of water to wells in most of the area, as transmissivities are high ranging from 160,000 to 200,000, gpd/ft. according to available data. Transmissivities decrease down dip to less than 40,000 gpd/ft at Karnes City. Specific capacities in Carrizo wells range from less than 10 to 50 gpm/ft. Well yields range up to about 2,000 gpm in many wells. Well pumping rates can be quite high because down dip the aquifer is deep and water levels are shallow, often flowing.

The Carrizo appears to supply suitable water for public supply throughout all of Frio and Atascosa Counties. Water below the secondary drinking water limit of 1000 mg/L for total dissolved solids is found as far down dip as near the Wilson-Karnes County lines. In fact, Falls City obtains its public supply from Carrizo wells. Further downdip, the quality of Carrizo water deteriorates to the slightly saline limit (3,000 mg/L TDS) within a relatively short distance. The reported approximate down dip limits of Carrizo water having less than 1,000 mg/L and less than 3,000 mg/L total dissolved solids are shown in Figure 3.1-4. Historical records show that the Carrizo has TDS greater than 3,000 mg/L in southeastern Karnes County.

The Carrizo is the most developed aquifer in the area, primarily due to large increases in irrigation pumpage beginning in the 1950's and 1960's. Data from 1969 show that the Carrizo irrigation pumpage was about 228 MGD, while public supply pumpage accounted for about 8 MGD, or 3

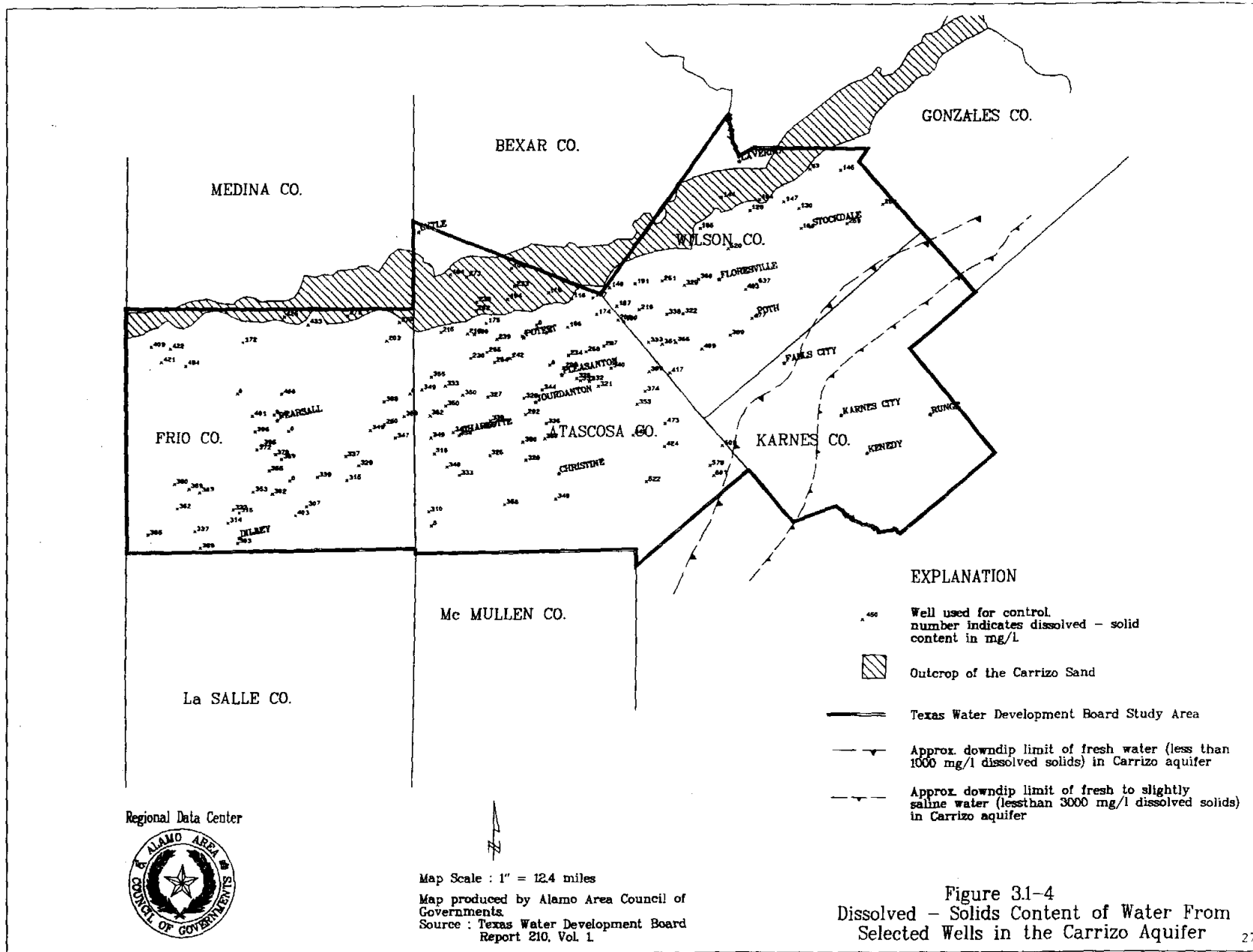

percent of the total pumpage. Water level declines since about 1970 have been only a few tens of feet in the artesian or down dip portions of the aquifer, according to available information.

The Texas Water Development Board (TWDB) reported in 1976 that the Carrizo Aquifer was being overpumped near Pearsall in Frio County. This projection was based on a model simulation with a condition that water-levels should not be lowered to greater than 400 feet below ground level. This water-level limit is extremely conservative and is based on aquifer conservation concerns and economic considerations of the cost to pump deeper groundwater. In reality, water-levels 400 feet deep would still generally be several hundred feet above the top of the aquifer in much of the study area, and pumping groundwater from over 1,000 feet deep is generally less costly than other water supply alternatives.

Based on historical pumpage and water-level information, and on standard projections for future pumpage, the Carrizo Aquifer should be able to meet projected needs throughout the planning period. Even with unexpected and large regional pumpage increases, water-level declines would likely not significantly limit the availability of municipalities to obtain their future water supply needs from the Carrizo Aquifer.

The primary factor limiting increased development of the Carrizo Aquifer is water quality. Frio, Atascosa, and Wilson Counties should be able to obtain suitable quality Carrizo water. However, Falls City is near the poor quality water line, and future significant groundwater development could possibly affect quality of Carrizo water in the area.

### **3.1.3 Queen City**

The Queen City Sand forms the aquifer above the Carrizo, and is separated from the Carrizo by the Reklaw Formation. The Queen City Sand consists of strata of thick sand, clay, and sandy clay, with sand sections typically consisting of loosely cemented sandstone with interbedded clays. The Queen City ranges in thickness from about 500 feet in Atascosa and Wilson Counties to 1,400 feet in Frio County.

The Queen City outcrop is generally parallel to the Carrizo and is shown in Figure 3.1-5. The

Queen City dips southward about 50 feet per mile in Frio County, and about 100 to 150 feet per mile in Atascosa County. Pearsall and Floresville are located within the outcrop area, while the depth to the top of the formation is about 600 to 650 feet at Pleasanton, and about 1,500 feet at Falls City. In eastern Karnes County, the Queen City is deeper than 3,700 feet below land surface.

Queen City wells are reportedly used primarily for irrigation and domestic purposes in and near the outcrop area. Transmissivity values from tests in Atascosa County are about 15,000 gpd/ft., much lower than Carrizo values. Well yields are reported to be low to moderate in primarily shallow wells in Frio County, and moderate to large in Atascosa County, where wells are deeper and artesian. Pleasanton obtains its water supply from Queen City wells with average pumping rates of about 400 gpm.

Queen City wells produce generally suitable drinking water in its outcrop and areas slightly downdip. Water quality becomes mineralized rapidly downdip. Figure 3.1-5 shows the approximate location of the down dip limit of slightly saline water (TDS of 3,000 mg/L).

The Queen City Aquifer has not been highly developed in the area. Since 1970, water-levels in wells have declined by only about 30 feet, according to available records. Future water supplies could likely be obtained from the aquifer, especially in Frio and Atascosa Counties. Usage of Queen City water in Wilson and Karnes Counties is limited by water-quality.

### **3.1.4 Secondary Aquifers**

#### **Catahoula Formation**

The Catahoula Formation crops out in northern Karnes County and is not found in Frio, Atascosa, or Wilson Counties. The Catahoula, sometimes referred to as the Catahoula Tuff, is composed of sandstone, pyroclastics such as ash or tuff, clay, and some conglomerate. The maximum thickness of the Catahoula is about 1,700 feet.

Reported transmissivities from aquifer test in Catahoula are low, ranging from about 1,400 to 5,000 gpd/ft. The Catahoula Aquifer provides small to moderate quantities of water to wells in Karnes

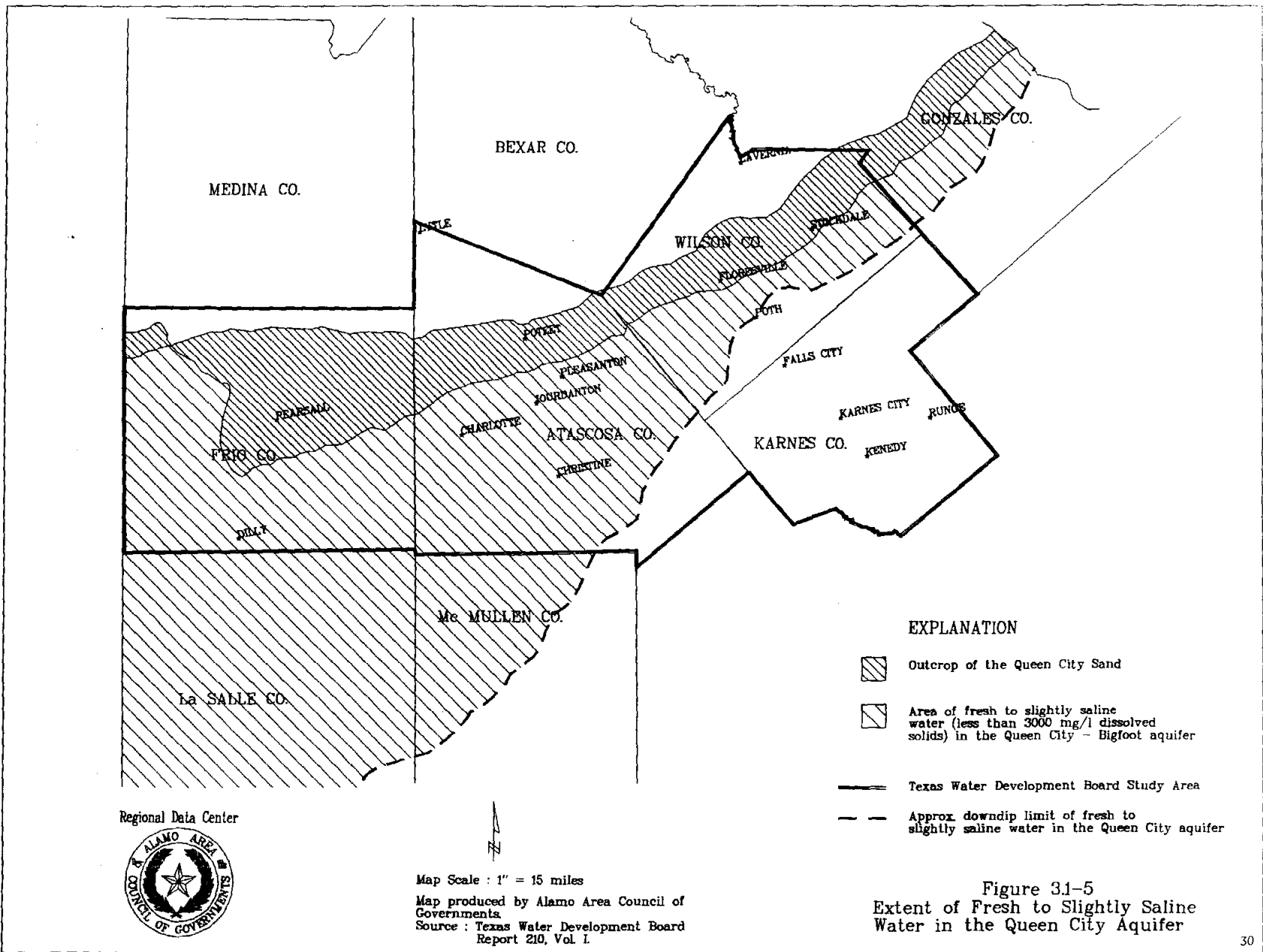

County, with yields commonly 200 to 300 gpm. The aquifer is only slightly developed in Karnes county, and water levels have apparently declined only slightly, according to available records.

The Catahoula yields suitable quality water for public supply primarily in the outcrop areas and slightly downdip. Water from downdip wells can be high in chlorides, fluorides and total dissolved solids, and should be treated prior to consumptive use.

### Oakville Sandstone

The Oakville Sandstone overlies the Catahoula Formation and crops out in the southern half of Karnes County. The Oakville Sandstone consists of sand, sandstone, sandy clay, ashy or bentonitic clay, marl and some gravel. The sand units are generally more massive and coarser than those in the Catahoula. The maximum thickness of the Oakville is about 950 feet.

The Oakville Aquifer is capable of supplying small to large quantities of water to wells and is an important aquifer in Karnes and De Witt Counties. Transmissivities in the Oakville Aquifer range from about 8,000 to 16,000 gpd/ft. Typical well yields range up to 400 gpm in Karnes County.

Available information indicates that Oakville water quality can be variable, even in the outcrop portion of the aquifer. The City of Runge has reported water with less than 1,000 mg/L TDS, but with chloride concentrations of greater than 300 mg/L. In some areas, the Oakville supplies suitable drinking water needing no treatment.

Available water-level data indicate that water levels in Oakville wells near the City of Runge have declined by only about 13 feet since 1953. It appears that the Oakville will likely be able to continue meeting projected water-supply demands in southern Karnes County in future years.

## **3.2 SURFACE WATER SOURCES**

The AACOG project area falls within two river basins: The San Antonio River Basin and the Nueces River Basin. The nearest surface water impounding to this project area is Choke Canyon Reservoir located along the Frio River (Nueces River Basin) in Live Oak County. Pleasanton and Kenedy are

the two closest participating municipalities to this surface water resource at a strait line distance of 32 miles. The City of Corpus Christi owns the majority of water rights in Choke Canyon Reservoir.

Three new lakes are proposed near the project area prior to year 2040. These lakes include the Lindenau and Cuero Reservoirs to be constructed in the Guadalupe River Basin in Dewitt County and the Goliad Reservoir to be constructed in the San Antonio River Basin in Goliad County. All three of these reservoirs are proposed as a water source for the City of San Antonio.

Water quality in all of the existing and proposed reservoirs should be adequate to meet drinking water standards after treatment.

Figure 3.2-1 shows the existing and proposed surface water impoundments near the AACOG project area.

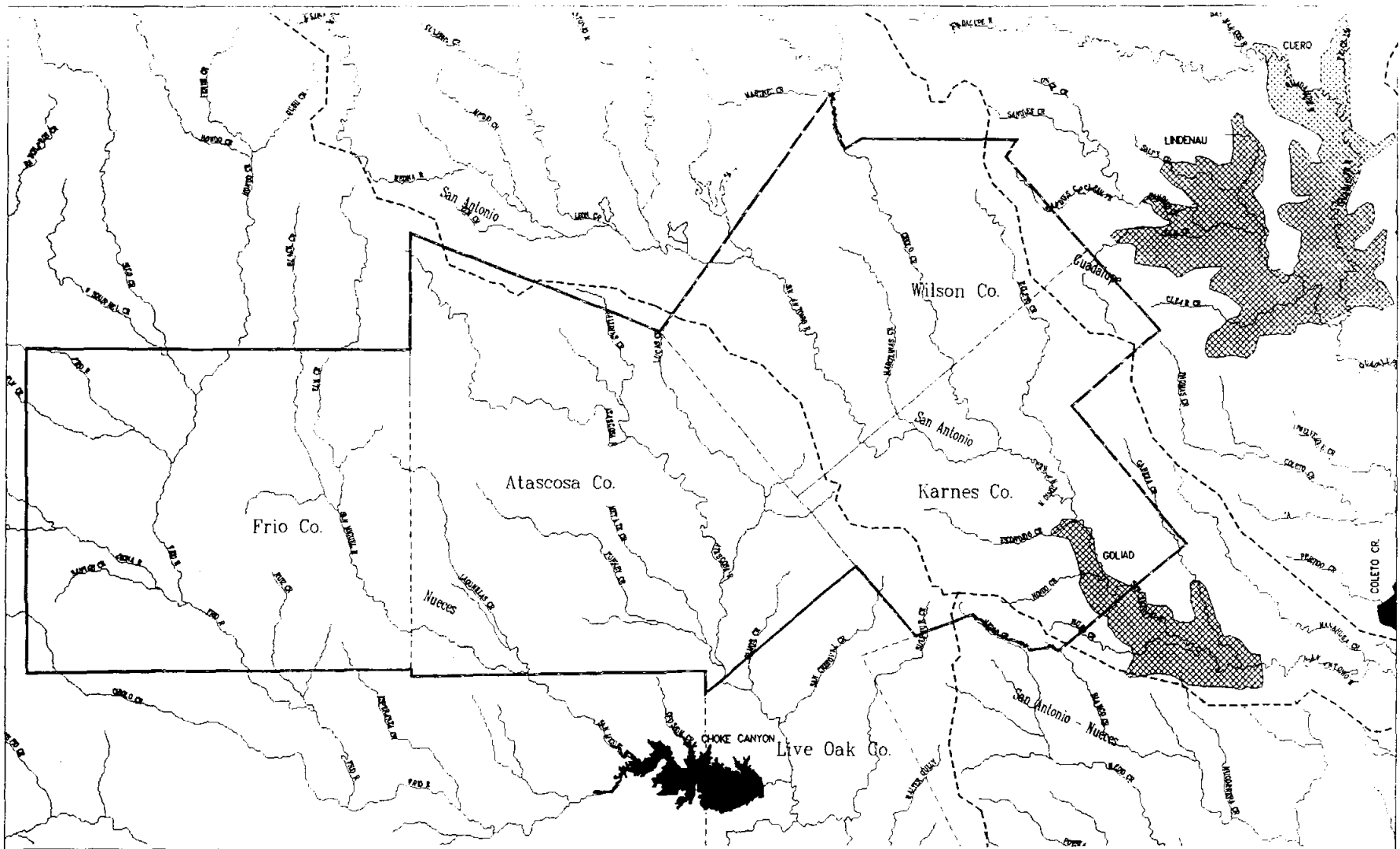

Map Legend

- TWDB Study Area Boundary
- County Boundary
- Hydrology
- Basin Boundary
- Existing Lake
- Proposed Lake

Figure 3.2-1

Existing and Proposed Surface Water Improvements near the ACOG Project Area

Map Scale : 1" = 9.3 miles

Map prepared by Alamo Area Council of Governments. Source data provided from District Consulting Engineers, Inc. and Texas with assistance and/or data from the Environmental Protection Agency.

Regional Data Center





## **4.0 EXISTING WATER SUPPLY FACILITIES**

### **4.1 GENERAL**

All participating municipalities were visited by Thonhoff Consulting Engineers, Inc., during October, 1993. Capacities of each water system component were tabulated and the site inspection allowed interpretation of its present operating condition. The water supply, treatment, and distribution system of each participating municipality was evaluated and compared to current TNRCC design criteria.

Of particular concern to all participating municipalities was the present condition and capability of their existing groundwater wells. Table 4.1-1 tabulates groundwater source and well data for each participating municipality. This table was used to estimate when a well would require replacement assuming an operating life of 50 years.

For several participating municipalities, water quality is a concern. Table 4.1-2 tabulates water quality constituents and compares them to TNRCC standards for drinking water quality.

Generally, all participating municipalities currently have adequate water quantity. Those municipalities in Central Karnes County have groundwater supply which marginally exceeds drinking water criteria for Total Dissolved Solids, Chloride, and Sodium.

### **4.2 CITY OF FALLS CITY**

Falls City, Texas had a 1990 population of 478 and recorded 253 water service connections.

The City has two flowing artesian wells approximately 3600 ft. deep drilled in the Carrizo Sands Aquifer. Each well has a rated capacity of about 700 gpm totalling 1400 gpm.

Existing ground storage consists of one 150,000 gallon reservoir and one 15,000 gallon storage tank prior to the aerator. Total ground storage capacity is 165,000 gallons.

**TABLE 4.1-1  
GROUNDWATER AND WELL DATA  
ON PARTICIPATING MUNICIPALITIES  
IN AACOG PROJECT AREA**

<u>CITY</u>	<u>WELL NO. OR NAME</u>	<u>DEPTH (ft)</u>	<u>CAPACITY AQUIFER</u>	<u>(ft)</u>	<u>YR.OF CONS.</u>
FALLS CITY	NO. 2	3564	CARRIZO	700	1962
"	NO. 3	3607	CARRIZO	700	1993
FLORESVILLE	NO. 2	960	CARRIZO	750	1950
"	NO. 3	1260	CARRIZO	1400	1962
"	NO. 4	1400	CARRIZO	1400	1986
KARNES CITY	NO. 3	872	CATAHOULA	120	1950
"	NO. 4	1015	CATAHOULA	250	1954
"	NO. 5	905	CATAHOULA	200	1965
KENEDY	NO. 3	400	CATAHOULA	175	1943
"	NO. 4	300	CATAHOULA	243	1947
"	NO. 5	400	CATAHOULA	250	1948
"	NO.6	430	CATAHOULA	290	1948
"	NO. 8	600	CATAHOULA	320	1969
"	NO. 9	?	CATAHOULA	230	1985
"	NO.10	598	CATAHOULA	600	1993
PEARSALL	BERRY RANCH RD. (North Well)		CARRIZO	1300	1957
"	MESQUITE ST. (East Well)		CARRIZO	650	1950
"	COLORODO ST. (NO.6)	1572	CARRIZO	1300	1963
"	COMAL ST.	1541	CARRIZO	1300	1977
PLEASANTON	MAIN YD#	11700	CARRIZO	510	1954
"	MAIN YD#2	810	QUEEN CITY	330	1959
"	MAIN YD#3 (Troell)	800	QUEEN CITY	220	1954
"	MAIN YD#4 (Gabrysch)	823	QUEEN CITY	300	1972
"	GOODWIN (#1)	845	QUEEN CITY	310	1974
"	NORTH- TOWN(#1)	790	QUEEN CITY	500	1962
"	JIMMY SEAL (North Town #2)	763	QUEEN CITY	360	1978
"	HALPIN	722	QUEEN CITY	500	1966
"	WOODLAND (#1)	750	QUEEN CITY	340	1982
RUNGE	NO. 1	156	OAKVILLE	100	1914 ?
"	NO. 2	212	OAKVILLE	100	1937 ?
"	NO. 3	212	OAKVILLE	100	1977

**TABLE 4.1-2  
COMPARISON OF GENERAL WATER QUALITY OF PARTICIPATING MUNICIPALITIES**

<u>CONSTITUENT</u>	<u>TNRCC SECONDARY STANDARD</u>	<u>FALLS CITY</u>	<u>FLORESVILLE</u>	<u>KARNES CITY (EL OSO)(#3)</u>	<u>KENEDY*</u>	<u>PEARSALL*</u>	<u>PLEASANTON</u>	<u>RUNGE*</u>
Total Dissolved Solids	1000 mg/l	705	365	775 (1361)	1484*	383	493	802
Chloride	300 mg/l	85	40	94 (526)	567*	26	106	328*
Sodium	----	297	60	317 (529)	458	30	131	131
Sulfate	300 mg/l	31	50	24 (89)	150	58	60	38
Fluoride	2.0 mg/l	0.8	0.9	1.2 (0.7)	1.0	0.5	0.5	0.7
Iron	0.3 mg/l	0.02	----	0.18 (2.3)	1.58	0.2*	<0.02	----
Manganese	0.05 mg/l	----	----	----(----	----	0.04	----	----
p H	≥ 7.0	7.5	8.1	8.2 (8.3)	7.9	7.4	8.1	7.7
Total Hardness	NA	----	163	19 (40)	242	267	145	442
Raw Water Temp.(°C)	----	----	----	----(33.1)	----	----	----	----

\*Kenedy has exceeded limits on:

Total Dissolved Solids	> 1000 mg/l w/1484 mg/l
Chloride	> 300 mg/l w/567 mg/l
Arsenic	> 0.05 mg/l w/ 0.067
Iron	> 0.3 mg/l w/ 1.58
Ethylbenzene	> 0.7 mg/l w/ 1.3

\*Pearsall has exceeded Iron limits due to Iron Bacteria growth, but can control this problem with well remediation

\*Runge has exceeded limits on:

Chloride	> 300 mg/l w/328 mg/l
----------	-----------------------

The water facilities include three high service pumps of 500 gpm, 300 gpm, and 200 gpm capacities. Total high service pumping capacity is 1000 gpm.

Pressure maintenance facilities will include one 10,000 gallon hydropneumatic pressure tank that is currently under construction.

The rated capacity for these existing water supply facilities based upon number of connections is as follows:

Wells:	2333 connections
Ground Storage:	825 connections
High Service Pumping:	500 connections
Pressure Maintenance:	500 connections

The City's existing water facilities appear adequate for the current 253 connections. The system's limiting rated capacity of 500 connections is projected beyond year 2040. Table 4.2-1 presents water supply facilities projections for Falls City. Refer to Figure 4.2-1 for City of Falls City Water System Schematic.

### **4.3 CITY OF FLORESVILLE**

Floresville, Texas had a 1990 census population of 5,247 and recorded 1928 water service connections.

The City has three groundwater wells in operation. Each well is drilled in the Carrizo Sands Aquifer and have respective rated capacities of 750 gpm, 1300 gpm, and 1300 gpm totalling 3350 gpm. Well depth varies from 960 ft. to 1400 ft. The City incorporates three (3) water production sites.

Ground storage at Site No. 1 includes 3 tanks of 65,000 gallons each and one tank of 80,000 gallons. Site No. 2 utilizes one tank of 250,000 gallons. Site No. 3 utilizes one tank of 90,000 gallons. Total ground storage capacity is 615,000 gallons.

TABLE 4.2-1  
CITY OF  
**FALLS CITY**  
WATER SUPPLY FACILITIES PROJECTIONS

YEAR	PROJECTED POPULATION	PROJECTED CONNECTIONS	PROJECTED PER CAPITA SUPPLY REQUIREMENT (gpcd)	PROJECTED AVG. DAY WATER SUPPLY REQUIREMENT (MGD)	PROJECTED MAX. DAY WATER SUPPLY REQUIREMENT (MGD)	PROJECTED TNRCC WATER SUPPLY REQUIREMENT (MGD)	AVAILABLE WATER SUPPLY (MGD)	ADDITIONAL WATER SUPPLY REQUIREMENT (MGD)	PROJECTED GROUND STORAGE REQUIREMENTS (GALLONS)	ADDITIONAL GROUND STORAGE REQUIREMENTS (GALLONS)	PROJECTED H.S. PUMPING REQUIREMENT (GPM)	ADDITIONAL H.S. PUMPING REQUIREMENT (GPM)	PROJECTED PRES. MAINTENANCE STORAGE REQUIREMENT (GALLONS)	ADDITIONAL PRES. MAINTENANCE STORAGE REQUIREMENT (GALLONS)
<b>TWDB LOW POPULATION PROJECTIONS</b>														
1990	478	230	190	0.091	0.235	0.219	2.016	0.0	50,600	0.0	506	0.0	25,300	0.0
2000	484	256	210	0.102	0.268	0.222	2.016	0.0	51,200	0.0	512	0.0	25,600	0.0
2010	499	264	210	0.105	0.271	0.228	2.016	0.0	52,800	0.0	528	0.0	26,400	0.0
2020	507	268	210	0.106	0.274	0.232	2.016	0.0	53,600	0.0	536	0.0	26,800	0.0
2030	518	274	210	0.109	0.281	0.237	2.016	0.0	54,800	0.0	548	0.0	27,400	0.0
2040	525	278	210	0.110	0.284	0.240	2.016	0.0	55,600	0.0	556	0.0	27,800	0.0

**TWDB HIGH POPULATION PROJECTIONS**

1990	478	253	190	0.091	0.235	0.218	2.016	0.0	50,600	0.0	506	0.0	25,300	0.0
2000	512	271	210	0.108	0.279	0.234	2.016	0.0	54,200	0.0	542	0.0	27,100	0.0
2010	535	283	210	0.112	0.289	0.245	2.016	0.0	56,600	0.0	566	0.0	28,300	0.0
2020	547	289	210	0.115	0.297	0.250	2.016	0.0	57,800	0.0	578	0.0	28,900	0.0
2030	561	297	210	0.118	0.304	0.256	2.016	0.0	59,400	0.0	594	0.0	29,700	0.0
2040	568	301	210	0.119	0.307	0.261	2.016	0.0	60,200	0.0	602	0.0	30,100	0.0

1. 2.08 CAPITA PER CONNECTION
2. 2.58 MAX. DAY TO AVG. DAY RATIO
3. 2.016 M.G.D. EXISTING WATER WELL SUPPLY
4. 165,000 GAL. EXISTING GROUND STORAGE CAPACITY
5. 1,000 G.P.M. EXISTING HIGH SERVICE PUMPING CAPACITY
6. 10,000 GAL HYDROPNEUMATIC TANK EXISTING PRESSURE MAINTENANCE CAPACITY
7. 0.6 G.P.M. PER CONNECTION TNRCC WATER SUPPLY CRITERIA
8. 200 GAL. PER CONNECTION TNRCC GROUND STORAGE CAPACITY CRITERIA
9. 2 G.P.M. PER CONNECTION TNRCC HIGH SERVICE PUMPING CRITERIA
10. 100 GAL. PER CONNECTION TNRCC PRESSURE MAINTENANCE STORAGE CRITERIA

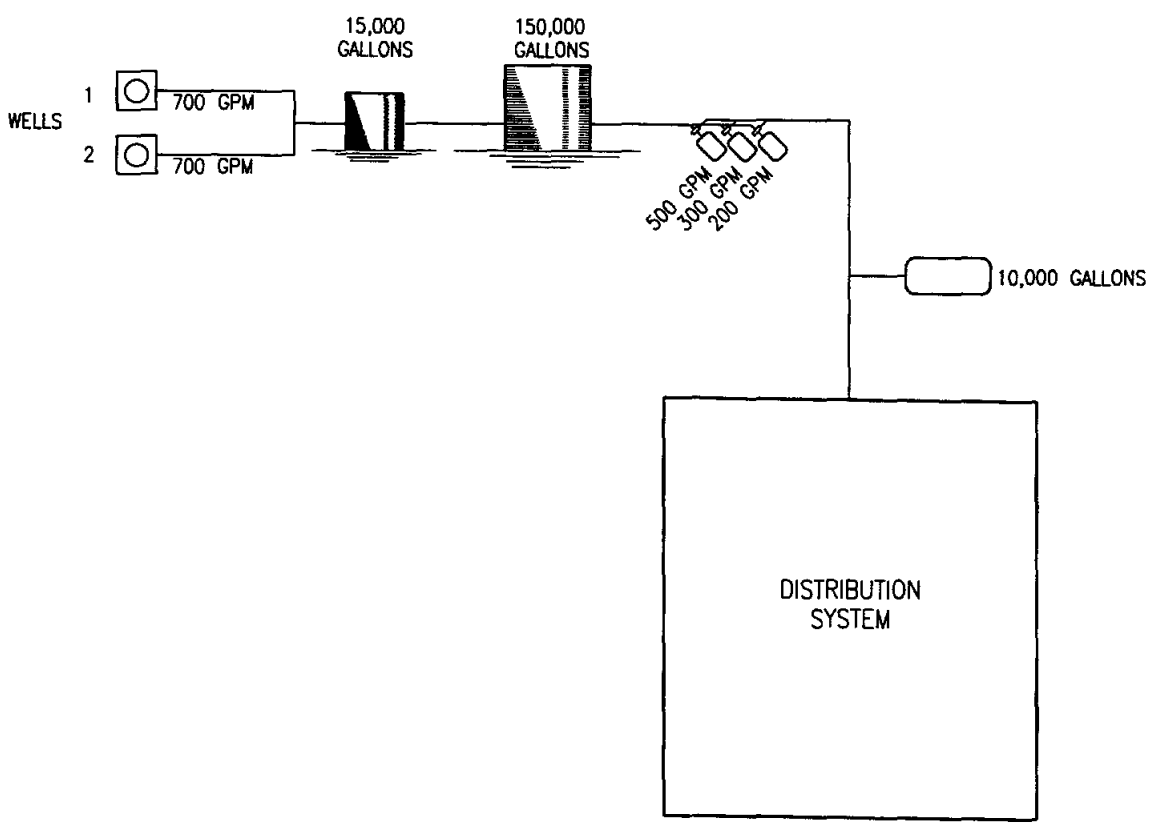
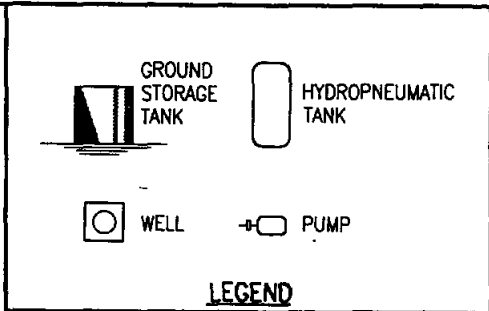

**FIGURE 4.2-1**  
**CITY OF FALLS CITY WATER SYSTEM SCHEMATIC**

High Service pumping includes 2 - 625 gpm pumps and 1 - 1800 gpm pump (currently abandoned) at Site No. 1. Site No. 2 uses 2 - 725 gpm pumps and Site No. 3 has 1 - 625 gpm pump, 1 - 500 gpm pump, and 1 - 225 gpm pump. Total high service pumping capacity is 4050 gpm.

Pressure Maintenance Storage includes 1 - 50,000 gallon tank at Site No. 1, 1 - 250,000 gallon tank at Site No. 2, and 2 - 50 gallon hydropneumatic tanks at Site No. 3. Total pressure maintenance storage capacity is 300,000 gallons.

The rated capacities for these existing water supply facilities based upon number of connections is as follows:

Wells:	5583 connections
Ground Storage:	3075 connections
High Service Pumping:	2025 connections
Pressure Maintenance:	3000 connections

The City's existing water facilities appear adequate for the current 1928 connections. The system's limiting rated capacity of 2025 connections results from high service pumping. The City should repair or replace the currently abandoned 1800 gpm pump at Site No. 1 and increase system high service pumping rated capacity to support 3025 connections. The noted 2025 connections has probably been surpassed as of this dated. The 3025 connections will be reached sometime between year 2010 and 2020. Table 4.3-1 presents water supply facilities projections for the City of Floresville. Refer to Figure 4.3-1 for City of Floresville Water System Schematic.

#### **4.4 CITY OF KARNES CITY**

Karnes City, Texas had a 1990 census population of 2916 and recorded 1144 water service connections.

The City has three groundwater wells noted as Well No. 3, No. 4, and No. 5. Well No. 3 is 872 ft. deep and has rated capacity of 120 gpm. Well No. 4 is 1015 ft. deep and has a rated capacity of 250 gpm. Well No. 5 is 905 ft. deep and has rated capacity of 200 gpm. Total groundwater well

TABLE 4.3-1

CITY OF  
**FLORESVILLE**  
 WATER SUPPLY FACILITIES PROJECTIONS

YEAR	PROJECTED POPULATION	PROJECTED CONNECTIONS	PROJECTED PER CAPITA SUPPLY REQUIREMENT (gpcd)	PROJECTED AVG. DAY WATER SUPPLY REQUIREMENT (MGD)	PROJECTED MAX. DAY WATER SUPPLY REQUIREMENT (MGD)	PROJECTED TNRCC WATER SUPPLY REQUIREMENT (MGD)	AVAILABLE WATER SUPPLY (MGD)	ADDITIONAL WATER SUPPLY REQUIREMENT (MGD)	PROJECTED GROUND STORAGE REQUIREMENTS (GALLONS)	ADDITIONAL GROUND STORAGE REQUIREMENTS (GALLONS)	PROJECTED H.S. PUMPING REQUIREMENT (GPM)	ADDITIONAL H.S. PUMPING REQUIREMENT (GPM)	PROJECTED PRES. MAINTENANCE STORAGE REQUIREMENT (GALLONS)	ADDITIONAL PRES. MAINTENANCE STORAGE REQUIREMENT (GALLONS)
<b>TWDB LOW POPULATION PROJECTIONS</b>														
1990	5247	1928	178	0.932	2.209	1.666	4.824	0.0	385,600	0.0	3856	0.0	192,800	0.0
2000	6470	2379	181	1.171	2.775	2.055	4.824	0.0	475,800	0.0	4758	708	237,900	0.0
2010	7637	2808	181	1.382	3.275	2.426	4.824	0.0	560,400	0.0	5604	1554	280,800	0.0
2020	8367	3076	181	1.514	3.588	2.658	4.824	0.0	615,200	200	6152	2102	307,600	7600
2030	8939	3286	181	1.618	3.835	2.839	4.824	0.0	657,200	42,200	6572	2522	328,600	28,600
2040	9354	3439	181	1.692	4.010	2.971	4.824	0.0	687,800	72,800	6878	2828	343,900	43,900
<b>TWDB HIGH POPULATION PROJECTIONS</b>														
1990	5247	1928	178	0.932	2.209	1.666	4.824	0.0	385,600	0.0	3856	0.0	192,800	0.0
2000	6785	2494	181	1.228	2.910	2.155	4.824	0.0	498,800	0.0	4988	938	249,400	0.0
2010	8270	3040	181	1.497	3.548	2.627	4.824	0.0	608,000	0.0	6080	2020	304,000	4000
2020	9228	3393	181	1.670	3.958	2.932	4.824	0.0	678,600	63,600	6786	2736	339,300	39,300
2030	10,070	3702	181	1.823	4.321	3.198	4.824	0.0	740,400	125,400	7404	3354	370,200	70,200
2040	10,836	3984	181	1.961	4.648	3.442	4.824	0.0	796,800	181,800	7968	3918	398,400	98,400

1. 2.72 CAPITA PER CONNECTION
2. 2.37 MAX. DAY TO AVG. DAY RATIO
3. 4.824 M.G.D. EXISTING WATER WELL SUPPLY
4. 615,000 GAL. EXISTING GROUND STORAGE CAPACITY
5. 4,050 G.P.M. EXISTING HIGH SERVICE PUMPING
6. 300,000 GAL. EXISTING PRESSURE MAINTENANCE CAPACITY
7. 0.6 G.P.M. PER CONNECTION TNRCC WATER SUPPLY CRITERIA
8. 200 GAL. PER CONNECTION TNRCC GROUND STORAGE CAPACITY CRITERIA
9. 2 G.P.M. PER CONNECTION TNRCC HIGH SERVICE PUMPING CRITERIA
10. 100 GAL. PER CONNECTION TNRCC PRESSURE MAINTENANCE STORAGE CRITERIA



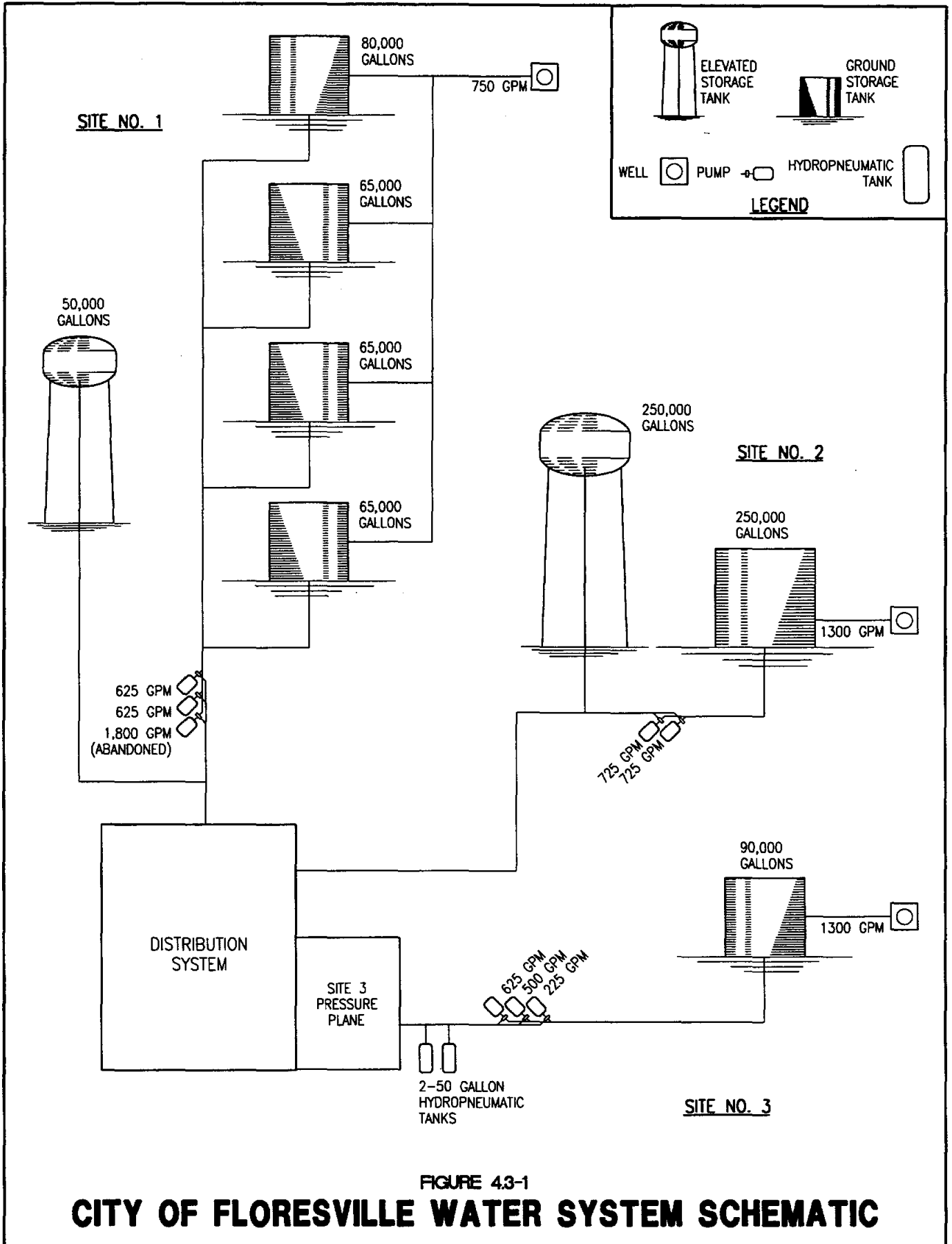

supply is 570 gpm. In addition, the City has a water supply contract with El Oso Water Supply Corporation to provide 20,000,000 gallons per month which equates to 457 gpm. Total water supply available to Karnes City is 1027 gpm or 1.479 MGD.

Ground Storage Tanks are located at each well site. Site No. 3 has a 114,000 gallon reservoir. Site No. 4 has a 101,000 gallon reservoir. Site No. 5 has a 216,000 gallon reservoir. Total ground storage capacity is 431,000 gallons not including ground storage capacity available through El Oso W.S.C. High Service Pumping utilizes 1 - 300 gpm pump at Site No. 3, 1 - 300 gpm pump at Site No. 4, and 1 - 600 gpm and 1 - 150 gpm pump at Site No. 5. Total high service pumping capacity is 1350 gpm. It is estimated that El Oso W.S.C. could supply up to 1000 gpm on an intermittent basis; therefore, total high services pumping capacity is approximately 2350 gpm.

Pressure Maintenance Storage utilizes one 250,000 gallon elevated storage tank at Site No. 3. Total pressure maintenance storage capacity for the City is 250,000 gallons.

The rated capacities for these existing water supply facilities are itemized as follows:

Wells and El Oso WSC:	1712 connection
Ground Storage:	2155 connections
High Service Pumping:	1175 connections
Pressure Maintenance:	2500 connections

The City's existing water facilities appear adequate for the current 1144 water service connections. High Service Pumping is the limiting unit process at 1175 connections which may be reached prior to year 2000. Should the City install one additional high service pump rated at 400 gpm, all component unit process requirements would probably be satisfied through the planning period. Refer to Figure 4.4-1 for City of Karnes City Water System Schematic.

#### **4.5 CITY OF KENEDY**

Kenedy, Texas had a 1990 census population of 3763 and recorded 1490 water service connections.

TABLE 4.4-1

CITY OF  
**KARNES CITY**  
WATER SUPPLY FACILITIES PROJECTIONS

YEAR	PROJECTED POPULATION	PROJECTED CONNECTIONS	PROJECTED PER CAPITA SUPPLY REQUIREMENT (gpcd)	PROJECTED AVG. DAY WATER SUPPLY REQUIREMENT (MGD)	PROJECTED MAX. DAY WATER SUPPLY REQUIREMENT (MGD)	PROJECTED TNRCC WATER SUPPLY REQUIREMENT (MGD)	AVAILABLE WATER SUPPLY (MGD)	ADDITIONAL WATER SUPPLY REQUIREMENT (MGD)	PROJECTED GROUND STORAGE REQUIREMENTS (GALLONS)	ADDITIONAL GROUND STORAGE REQUIREMENTS (GALLONS)	PROJECTED H.S. PUMPING REQUIREMENT (GPM)	ADDITIONAL H.S. PUMPING REQUIREMENT (GPM)	PROJECTED PRES. MAINTENANCE STORAGE REQUIREMENT (GALLONS)	ADDITIONAL PRES. MAINTENANCE STORAGE REQUIREMENT (GALLONS)
<b>TWDB LOW POPULATION PROJECTIONS</b>														
1990	2916	1144	126	0.366	0.763	0.988	1.479	0.0	228,800	0.0	2228	0.0	114,400	0.0
2000	2927	1149	135	0.395	0.821	0.993	1.479	0.0	229,800	0.0	2298	0.0	114,900	0.0
2010	3020	1184	135	0.407	0.847	1.023	1.479	0.0	236,800	0.0	2368	18	118,400	0.0
2020	3073	1205	135	0.415	0.863	1.041	1.479	0.0	241,000	0.0	2410	60	120,500	0.0
2030	3145	1233	135	0.425	0.884	1.065	1.479	0.0	246,600	0.0	2466	116	123,300	0.0
2040	3173	1244	135	0.429	0.892	1.075	1.479	0.0	248,800	0.0	2488	138	124,400	0.0

**TWDB HIGH POPULATION PROJECTIONS**

1990	2916	1144	126	0.366	0.763	0.988	1.479	0.0	228,800	0.0	2288	0.0	114,400	0.0
2000	3107	1218	135	0.419	0.872	1.052	1.479	0.0	243,600	0.0	2436	86	121,800	0.0
2010	3259	1278	135	0.440	0.915	1.104	1.479	0.0	255,600	0.0	2556	206	127,800	0.0
2020	3338	1309	135	0.451	0.938	1.130	1.479	0.0	261,800	0.0	2618	268	130,900	0.0
2030	3436	1347	135	0.464	0.965	1.163	1.479	0.0	269,400	0.0	2694	344	134,700	0.0
2040	3478	1364	135	0.470	0.978	1.178	1.479	0.0	272,800	0.0	2728	378	136,400	0.0

1. 2.55 CAPITA PER CONNECTION
2. 2.08 MAX. DAY TO AVG. DAY RATIO
3. 570 G.P.M. EXISTING WATER SUPPLY; 457 G.P.M. FROM EL OSO W.S.C.; TOTAL 1027 G.P.M. OR 1.479 M.G.D.
4. 431,000 GAL. EXISTING GROUND STORAGE CAPACITY
- 5A. 1350 G.P.M. EXISTING HIGH SERVICE PUMPING
- 5B. 1000 G.P.M.(EST.) EXISTING EL OSO HIGH SERVICE SUPPLY AVG. (20,000,000 GALLONS PER MONTH CONTRACTED)
6. 250,000 GAL. EXISTING PRESSURE MAINTENANCE CAPACITY
7. 0.6 G.P.M. PER CONNECTION TNRCC WATER SUPPLY CRITERIA
8. 200 GAL. PER CONNECTION TNRCC GROUND STORAGE CAPACITY CRITERIA
9. 2 G.P.M. PER CONNECTION TNRCC HIGH SERVICE PUMPING CRITERIA
10. 100 GAL. PER CONNECTION TNRCC PRESSURE MAINTENANCE STORAGE CRITERIA

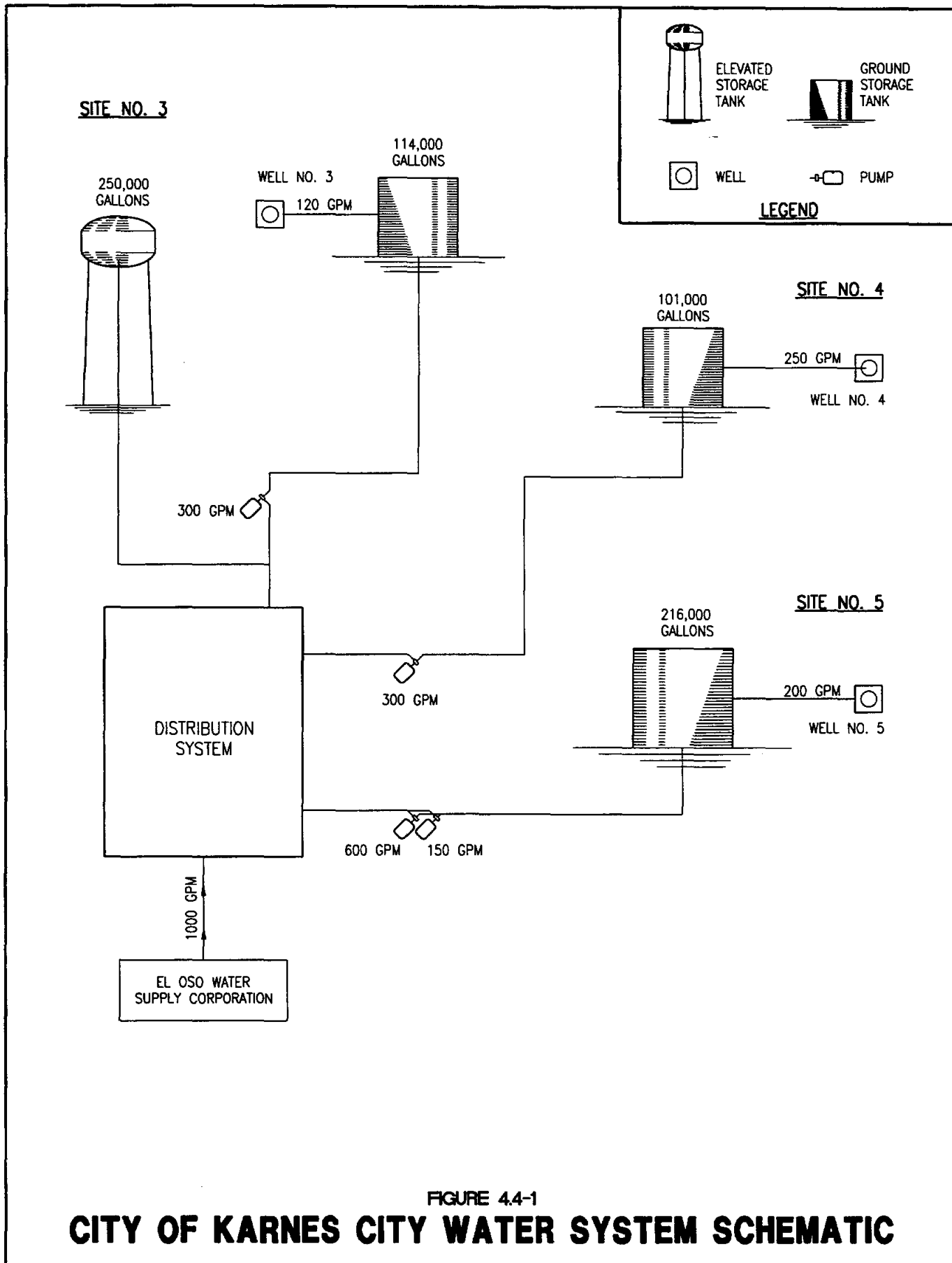

FIGURE 4.4-1

**CITY OF KARNES CITY WATER SYSTEM SCHEMATIC**

The city had ten (10) water well sites and three (3) sites are now abandoned. The City's water well sites and capacities are listed as follows:

No. 1:	Abandoned
No. 2:	Abandoned
No. 3:	175 gpm
No. 4:	243 gpm
No. 5:	250 gpm
No. 6:	290 gpm
No. 7:	Abandoned
No. 8:	320 gpm
No. 9:	230 gpm
No. 10:	600 gpm

The City's total water well capacity is 2108 gpm or 3.035 MGD. All but one well are drilled in the Catahoula Formation. The other well utilizes the Oakville Sandstone Aquifer.

Ground storage facilities include 2 - 50,000 gallon tanks located near the High School, 1 - 300,000 gallon reservoir near Well No. 10, and approximately 260,000 gallons of available storage within a standpipe. In addition, the City has 1 - 300,000 gallon reservoir currently out of service located at the City shop. Ground storage capacity currently in use totals 660,000 gallons.

High Service Pumping capacity essentially includes the well pumps totaling 2108 gpm plus 2 - 360 gpm pumps adjacent to the two 50,000 gallon tanks at the High School. Total high service pumping capacity is 2828 gpm.

Pressure Maintenance storage is provide by 540,000 gallons in the 800,000 gallon standpipe, 2 - 50,000 gallon elevated storage tanks, and 1 - 100,000 gallon elevated storage tank. A 400,000 gallon elevated storage tank is under construction at the new prison site. Total pressure maintenance storage capacity (existing and under construction) is 1,140,000 gallons.

The rated capacities for the existing water supply facilities are tabulated as follows:

Wells:	3513 connections
Ground Storage:	2800 connections
High Service Pumping:	1414 connections
Pressure Maintenance:	8400 connections

The City's existing water facilities with the exception of high service pumping appear adequate to serve the existing 1490 connections. The limiting unit process is high service pumping which is rated at 1414 connections. The City should immediately install additional high service pumping of approximately 400 gpm to serve adequately until about year 2020 and then install another 400 gpm high service pumping capacity to meet projected demands through the planning period. Table 4.5-1 presents the water supply facilities projections for the City of Kenedy. Refer to Figure 4.5-1 for City of Kenedy Water System Schematic.

#### 4.6 CITY OF PEARSALL

Pearsall, Texas had a 1990 census population of 7518 and recorded 2379 water service connections. The City has four water wells drilled in the Carrizo Sands Aquifer. The water wells are itemized per the following locations:

Berry Ranch Road:	1300 gpm
Mesquite St.:	650 gpm
Colorado St.:	1300 gpm
Comal St.:	1300 gpm

Total water well capacity is 4550 gpm or 6.552 MGD.

Ground storage capacity is constructed at each well location and tabulated as follows:

Berry Ranch Road:	200,000 gallons
Mesquite St.:	75,000 gallons
Colorado St.:	500,000 gallons
Comal Street:	500,000 gallons

Total ground storage capacity is 1,275,000.

TABLE 4.5-1  
CITY OF  
**KENEDY**  
WATER SUPPLY FACILITIES PROJECTIONS

YEAR	PROJECTED POPULATION	PROJECTED CONNECTIONS	PROJECTED PER CAPITA SUPPLY REQUIREMENT (gpcd)	PROJECTED AVG. DAY WATER SUPPLY REQUIREMENT (MGD)	PROJECTED MAX. DAY WATER SUPPLY REQUIREMENT (MGD)	PROJECTED TNRCC WATER SUPPLY REQUIREMENT (MGD)	AVAILABLE WATER SUPPLY (MGD)	ADDITIONAL WATER SUPPLY REQUIREMENT (MGD)	PROJECTED GROUND STORAGE REQUIREMENTS (GALLONS)	ADDITIONAL GROUND STORAGE REQUIREMENTS (GALLONS)	PROJECTED H.S. PUMPING REQUIREMENT (GPM)	ADDITIONAL H.S. PUMPING REQUIREMENT (GPM)	PROJECTED PRES. MAINTENANCE STORAGE REQUIREMENT (GALLONS)	ADDITIONAL PRES. MAINTENANCE STORAGE REQUIREMENT (GALLONS)
<b>TWDB LOW POPULATION PROJECTIONS</b>														
1990	3763	1490	162	0.609	1.133	1.287	3.035	0.0	298,000	0.0	2980	152	149,000	0.0
2000	3817	1508	180	0.687	1.278	1.303	3.035	0.0	301,800	0.0	3016	188	150,800	0.0
2010	3926	1552	180	0.707	1.315	1.340	3.035	0.0	310,400	0.0	3104	276	155,200	0.0
2020	3989	1577	180	0.718	1.336	1.363	3.035	0.0	315,400	0.0	3154	326	157,700	0.0
2030	4075	1611	180	0.734	1.365	1.392	3.035	0.0	322,200	0.0	3222	394	161,100	0.0
2040	4110	1625	180	0.740	1.376	1.404	3.035	0.0	325,000	0.0	3250	422	162,500	0.0

**TWDB HIGH POPULATION PROJECTIONS**

1990	3763	1490	162	0.609	1.133	1.287	3.035	0.0	298,000	0.0	2980	152	149,000	0.0
2000	4029	1592	180	0.725	1.349	1.375	3.035	0.0	318,400	0.0	3184	356	159,200	0.0
2010	4210	1664	180	0.758	1.410	1.437	3.035	0.0	332,800	0.0	3328	500	166,400	0.0
2020	4304	1701	180	0.775	1.442	1.469	3.035	0.0	340,200	0.0	3402	574	170,100	0.0
2030	4420	1747	180	0.795	1.479	1.509	3.035	0.0	349,400	0.0	3494	666	174,700	0.0
2040	4470	1767	180	0.804	1.495	1.529	3.035	0.0	353,000	0.0	3534	706	176,700	0.0

1. 2.53 CAPITA PER CONNECTION
2. 1.86 MAX. DAY TO AVG. DAY RATIO
3. 3.035 M.G.D. EXISTING WATER WELL SUPPLY
4. 660,000 GAL. EXISTING GROUND STORAGE SUPPLY
5. 2,108 WELL H.S. CAPACITY; 720 GPM H.S. @ HOSPITAL; TOTAL 2,828 GPM
6. 1,140,000 GAL. EXISTING PRESSURE MAINTENANCE CAPACITY
7. 0.6 G.P.M. PER CONNECTION TNRCC WATER SUPPLY CRITERIA
8. 200 GAL. PER CONNECTION TNRCC GROUND STORAGE CAPACITY CRITERIA
9. 2 G.P.M. PER CONNECTION TNRCC HIGH SERVICE PUMPING CRITERIA
10. 100 GAL. PER CONNECTION TNRCC PRESSURE MAINTENANCE STORAGE CAPACITY

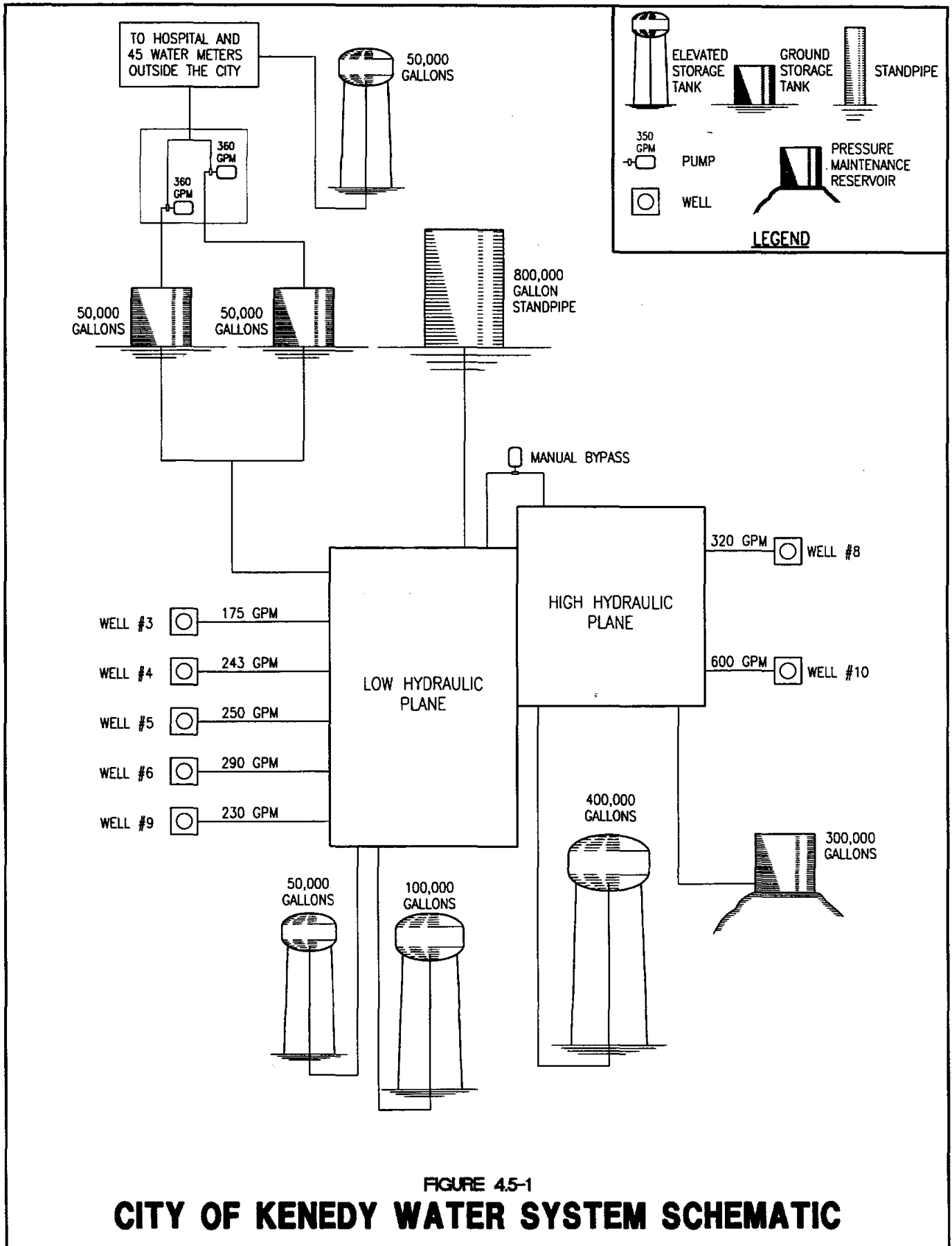

FIGURE 4.5-1

**CITY OF KENEDY WATER SYSTEM SCHEMATIC**



High service pumping is utilized at each site. The high service pumping capacity is as follows:

Berry Ranch Road:	2 @ 750 gpm each
Mesquite St.:	2 @ 350 gpm
Colorado St.:	2 @ 750 gpm
Comal St.:	3 @ 750 gpm

Total high service pumping capacity is 5950 gpm.

Elevated storage tanks are constructed at two sites and itemized as follows:

Berry Ranch Road:	200,000 gallons
Colorado St.:	250,000 gallons

Total pressure maintenance storage capacity is 450,000 gallons.

The rated capacities for the existing water supply facilities for the City of Pearsall are tabulated as follows:

Wells:	7583 connections
Ground Storage:	6375 connections
High Service Pumping:	2975 connections
Pressure Maintenance:	4500 connections

The City's existing water facilities appear adequate to serve the existing 2379 connections. The limiting unit process is the high service pumping which is rated to serve 2975 connections. Additional high service pumping should be installed about year 2010. For component reliability, the recommended locations for additional high service pumping is one additional 750 gpm pump at the Mesquite St. site and one additional 750 gpm pump at the Colorado St. site. With the high service pumping improvements, the water supply facilities should meet projected needs through the planning period. Table 4.6-1 presents the water supply facilities projections for the City of Pearsall. Refer to Figure 4.6-1 for City of Pearsall Water System Schematic.

TABLE 4.6-1  
CITY OF  
**PEARSALL**  
WATER SUPPLY FACILITIES PROJECTIONS

YEAR	PROJECTED POPULATION	PROJECTED CONNECTIONS	PROJECTED PER CAPITA SUPPLY REQUIREMENT (gpcd)	PROJECTED AVG. DAY WATER SUPPLY REQUIREMENT (MGD)	PROJECTED MAX. DAY WATER SUPPLY REQUIREMENT (MGD)	PROJECTED TNRCC WATER SUPPLY REQUIREMENT (MGD)	AVAILABLE WATER SUPPLY (MGD)	ADDITIONAL WATER SUPPLY REQUIREMENT (MGD)	PROJECTED GROUND STORAGE REQUIREMENTS (GALLONS)	ADDITIONAL GROUND STORAGE REQUIREMENTS (GALLONS)	PROJECTED H.S. PUMPING REQUIREMENT (GPM)	ADDITIONAL H.S. PUMPING REQUIREMENT (GPM)	PROJECTED PRES. MAINTENANCE STORAGE REQUIREMENT (GALLONS)	ADDITIONAL PRES. MAINTENANCE STORAGE REQUIREMENT (GALLONS)
<b>TWDB LOW POPULATION PROJECTIONS</b>														
1990	6924	2379	207	1.430	4.512	2.055	6.552	0.0	475,800	0.0	4758	0.0	237,900	0.0
2000	7317	2514	218	1.595	5.040	2.172	6.552	0.0	502,800	0.0	5028	0.0	251,400	0.0
2010	8724	2998	218	1.902	6.010	2.590	6.552	0.0	599,600	0.0	5996	0.0	299,800	0.0
2020	9624	3314	218	2.102	6.642	2.863	6.552	0.090	662,600	0.0	6626	676	331,400	0.0
2030	10,718	3683	218	2.336	7.318	3.182	6.552	0.766	736,600	0.0	7366	1416	368,300	0.0
2040	11,000	3780	218	2.397	7.575	3.266	6.552	1.023	756,000	0.0	7560	1610	378,300	0.0

**TWDB HIGH POPULATION PROJECTIONS**

1990	6924	2379	207	1.430	4.512	2.055	6.552	0.0	475,800	0.0	4758	0.0	237,900	0.0
2000	7337	2521	218	1.600	5.056	2.178	6.552	0.0	504,200	0.0	5042	0.0	252,100	0.0
2010	8782	3018	218	1.914	6.048	2.608	6.552	0.0	603,600	0.0	6036	0.0	301,800	0.0
2020	9786	3363	218	2.134	6.743	2.906	6.552	0.191	672,600	0.0	6726	776	336,300	0.0
2030	10,982	3774	218	2.394	7.565	3.261	6.552	1.013	754,800	0.0	7548	1598	377,400	0.0
2040	11,491	3949	218	2.505	7.916	3.412	6.552	1.364	789,800	0.0	7898	1948	394,900	0.0

1. 2.91 CAPITA PER CONNECTION
2. 3.16 MAX. DAY TO AVG. DAY RATIO
3. 6.552 M.G.D. EXISTING WATER WELL SUPPLY
4. 1,275,000 GAL. EXISTING GROUND STORAGE CAPACITY
5. 5,950 G.P.M. EXISTING HIGH SERVICE PUMPING
6. 450,000 GAL. EXISTING PRESSURE MAINTENANCE CAPACITY
7. 0.6 G.P.M. PER CONNECTION TNRCC WATER SUPPLY CRITERIA
8. 200 GAL. PER CONNECTION TNRCC GROUND STORAGE CAPACITY CRITERIA
9. 2 G.P.M. PER CONNECTION TNRCC HIGH SERVICE PUMPING CRITERIA
10. 100 GAL. PER CONNECTION TNRCC PRESSURE MAINTENANCE STORAGE CRITERIA

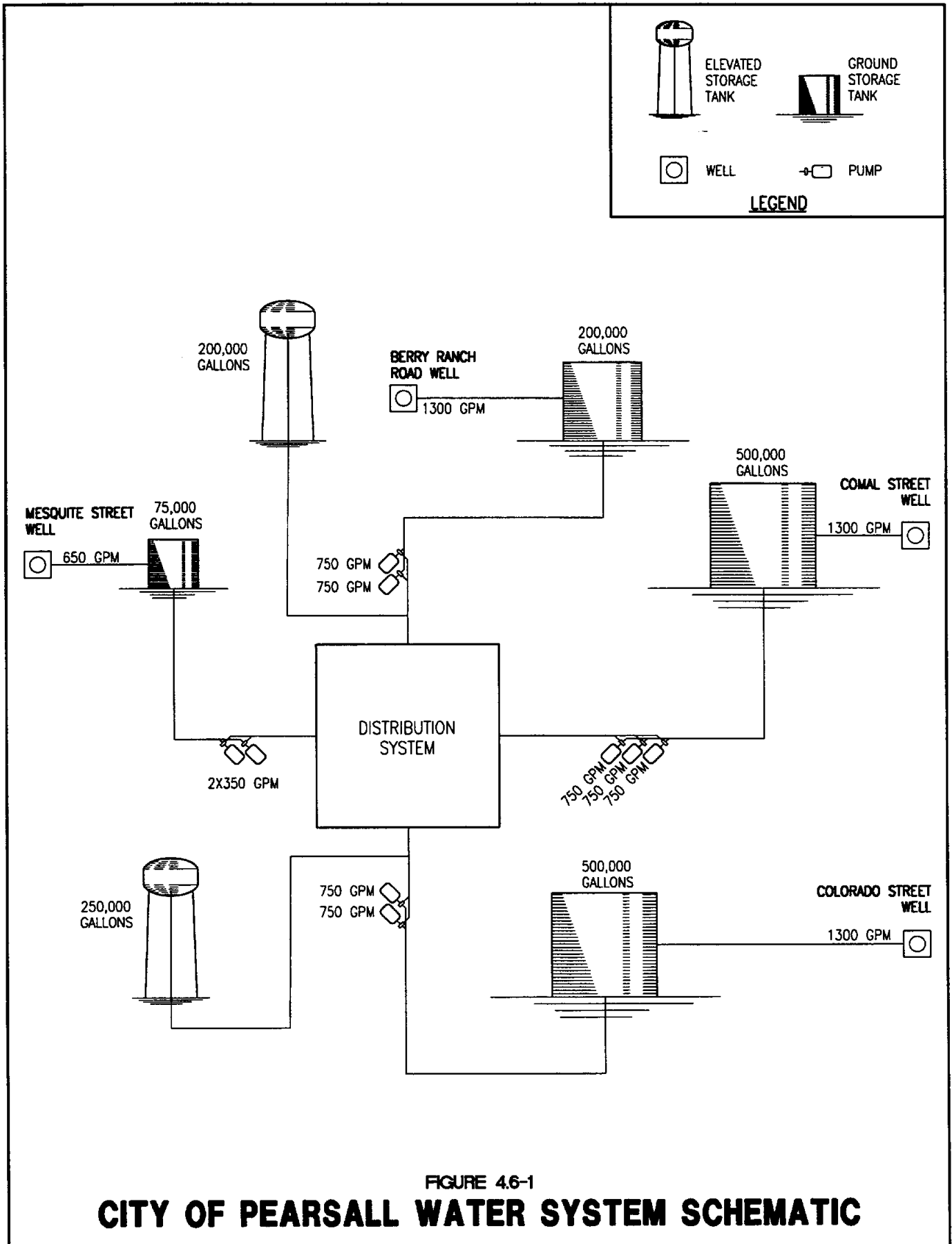

FIGURE 4.6-1

**CITY OF PEARSALL WATER SYSTEM SCHEMATIC**

#### 4.7 CITY OF PLEASANTON

Pleasanton, Texas had a 1990 census population of 7678 and recorded 2960 water service connections. The City incorporates nine (9) water wells located at five different sites. All water wells except one are drilled in the Queen City Aquifer. The other single water well is drilled in the Carrizo Sands Aquifer and is located at the Main Yard site. The existing water wells are tabulated as follows:

Main Yard Site:	510 gpm (Carrizo Aquifer)
Main Yard Site:	330 gpm
Main Yard Site:	220 gpm
Main Yard Site:	300 gpm
Goodwin Site:	310 gpm
North Town Site:	500 gpm
North Town Site:	360 gpm
Halpin Site:	500 gpm
Woodland Site:	340 gpm

Total water well capacity is 3370 gpm.

Ground storage capacity is constructed at each of the well sites. A tabulation of existing ground storage is as follows:

Main Yard Site:	1 @ 500,000 gallons
Goodwin Site:	1 @ 200,000 gallons
North Town Site:	1 @ 250,000 gallons and 1 @ 60,000 gallons
Halpin Site:	1 @ 500,000 gallons
Woodland Site:	1 @ 250,000 gallons

In addition, a ground storage tank utilized only for fire demand flows is located at the Industrial Site, and its capacity is 300,000 gallons. Total ground storage capacity not including fire demand reserve at the Industrial Site is 1,760,000 gallons.

High Service Pumping is available at each well site and is tabulated as follows:

Main Yard Site:	2 @ 800 gpm each, 1 @ 500 gpm
Goodwin Site:	1 @ 300 gpm, 1 @ 500 gpm
North Town Site:	2 @ 600 gpm each
Halpin Site:	1 @ 500 gpm (90 psi) and 1 @ 600 gpm (120 psi)
Woodland Site:	2 @ 400 gpm each, 1 @ 200 gpm

In addition, three fire demand pumps are located at the Industrial Site each rated at 800 gpm. The total high service pumping capacity not including reserved fire demand pumps at the Industrial Site and the 90 psi pump at the Halpin Site is approximately 6200 gpm.

Elevated storage is constructed at three of the noted sites as follows:

Main Yard Site:	250,000 gallons
Goodwin Site:	250,000 gallons
Halpin Site:	100,000 gallons

Total pressure maintenance capacity for the City is 600,000 gallons.

The rated capacities for the existing water supply facilities for the City of Pleasanton are tabulated as follows:

Water Wells:	5617 connections
Ground Storage:	8800 connections
High Service Pumping:	3150 connections
Pressure Maintenance:	6000 connections

The City's existing water facilities appear adequate for the City's existing 3101 connections. High service pumping is currently rated at 3150 connections and appears to be the limiting component. The City should consider adding high service pumping for the near future. Such high service pumping should be added to supplement the pressure planes with the greatest demand. It appears

that adding a 600 gpm pump at the Halpin Site and another 1200 gpm pump at the North Town Site may satisfy immediate needs through year 2000. After year 2000, the City may consider an additional 800 gpm pump at the Goodwin Site.

Elevated storage tanks should be considered to replace existing hydropneumatic pump stations for the Halpin and the Woodland pressure planes as component reliability needs and fire demand needs increase.

Prior to year 2020, the City should develop additional wells with greater than 700 gpm capacity to provide projected flows through the study period. Table 4.7-1 presents the water supply facilities projections for the City of Pleasanton. Refer to Figure 4.7-1 for City of Pleasanton Water System Schematic.

#### **4.8 CITY OF RUNGE**

Runge, Texas had 1990 census population of 444 and recorded 129 water service connections. The City has three water wells at a common site. The water wells are drilled in the Oakville Sandstone Aquifer. Two wells are 212 ft. in depth, and one well is 156 ft. in depth. Each well is rated at 100 gpm for a total groundwater supply capacity of 300 gpm or 0.432 MGD.

Ground storage is located at this same site. The City utilizes one 200,000 gallon ground storage tank and has one 80,000 gallon storage tank as standby. Also, at this site is one abandoned 80,000 storage tank. The existing utilized ground storage capacity is 200,000 gallons.

High service pumping capacity consists of three pumps. One pump is rated at 320 gpm, and the other two pumps are rated at 500 gpm each. Total high service pumping capacity is 1320 gpm.

The City has one elevated storage tank at this location with 150,000 gallons of capacity.

The rated capacities of the existing water supply facilities for the City of Runge are tabulated as follows:

TABLE 4.7-1

CITY OF  
**PLEASANTON**  
WATER SUPPLY FACILITIES PROJECTIONS

YEAR	PROJECTED POPULATION	PROJECTED CONNECTIONS	PROJECTED PER CAPITA SUPPLY REQUIREMENT (gpcd)	PROJECTED AVG. DAY WATER SUPPLY REQUIREMENT (MGD)	PROJECTED MAX. DAY WATER SUPPLY REQUIREMENT (MGD)	PROJECTED TNRCC WATER SUPPLY REQUIREMENT (MGD)	AVAILABLE WATER SUPPLY (MGD)	ADDITIONAL WATER SUPPLY REQUIREMENT (MGD)	PROJECTED GROUND STORAGE REQUIREMENTS (GALLONS)	ADDITIONAL GROUND STORAGE REQUIREMENTS (GALLONS)	PROJECTED H.S. PUMPING REQUIREMENT (GPM)	ADDITIONAL H.S. PUMPING REQUIREMENT (GPM)	PROJECTED PRES. MAINTENANCE STORAGE REQUIREMENT (GALLONS)	ADDITIONAL PRES. MAINTENANCE STORAGE REQUIREMENT (GALLONS)
<b>TWDB LOW POPULATION PROJECTIONS</b>														
1990	7678	2960	181	1.389	3.070	2.557	4.853	0.0	592,000	0.0	5,920	0.0	296,000	0.0
2000	9082	3507	179	1.626	3.594	3.030	4.853	0.0	701,000	0.0	7,010	810	351,000	0.0
2010	10,249	3957	179	1.835	4.055	3.419	4.853	0.0	791,000	0.0	7,910	1,710	396,000	0.0
2020	11,172	4314	179	2.000	4.420	3.727	4.853	0.0	863,000	0.0	8,630	2,430	431,000	0.0
2030	12,052	4653	179	2.157	4.767	4.020	4.853	0.0	931,000	0.0	9,310	3,110	465,000	0.0
2040	12,353	4769	179	2.211	4.886	4.120	4.853	0.033	954,000	0.0	9,540	3,340	477,000	0.0

**TWDB HIGH POPULATION PROJECTIONS**

1990	7678	2960	181	1.389	3.070	2.557	4.853	0.0	592,000	0.0	5,920	0.0	296,000	0.0
2000	9507	3671	179	1.702	3.761	3.172	4.853	0.0	734,000	0.0	7,340	1,140	367,000	0.0
2010	11,059	4270	179	1.979	4.374	3.689	4.853	0.0	854,000	0.0	8,540	2,340	427,000	0.0
2020	12,356	4771	179	2.211	4.886	4.122	4.853	0.033	954,000	0.0	9,540	3,340	477,000	0.0
2030	13,604	5253	179	2.435	5.381	4.539	4.853	0.528	1,051,000	0.0	10,510	4,310	525,000	0.0
2040	14,855	5736	179	2.659	5.876	4.956	4.853	1.023	1,147,000	0.0	11,470	5,270	574,000	0.0

1. 2.59 CAPITA PER CONNECTION
2. 2.21 MAX. DAY TO AVG. DAY RATIO
3. 4.853 M.G.D. EXISTING WATER WELL CAPACITY
4. 1,760,000 GAL. EXISTING GROUND STORAGE SUPPLY
5. 6,200 G.P.M. EXISTING HIGH SERVICE PUMPING
6. 600,000 GAL. EXISTING PRESSURE MAINTENANCE CAPACITY
7. 0.6 G.P.M. PER CONNECTION TNRCC WATER SUPPLY CRITERIA
8. 200 GAL. PER CONNECTION TNRCC GROUND STORAGE CAPACITY CRITERIA
9. 2 G.P.M. PER CONNECTION TNRCC HIGH SERVICE PUMPING CRITERIA
10. 100 GAL. PER CONNECTION TNRCC PRESSURE MAINTENANCE STORAGE CRITERIA

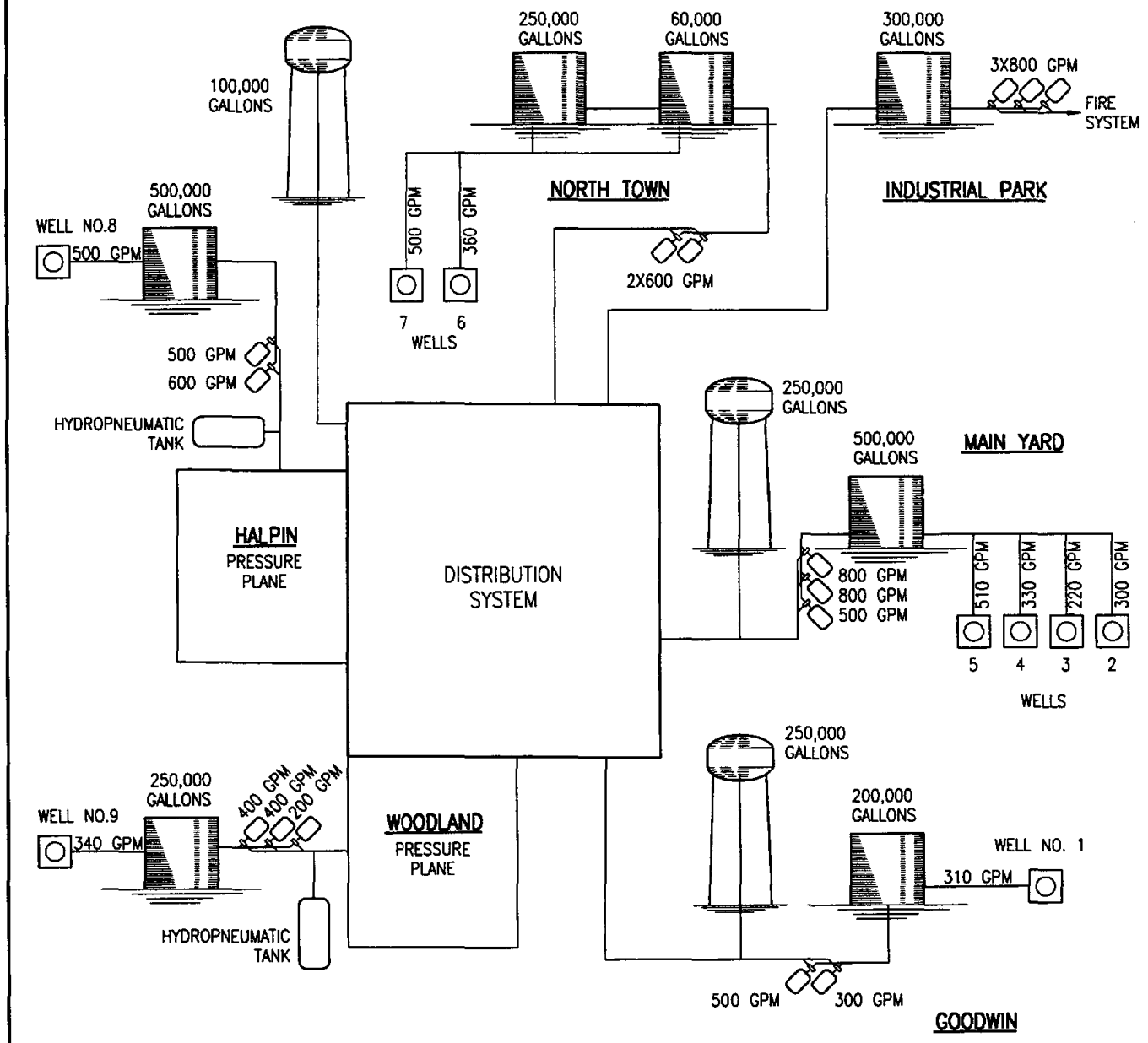
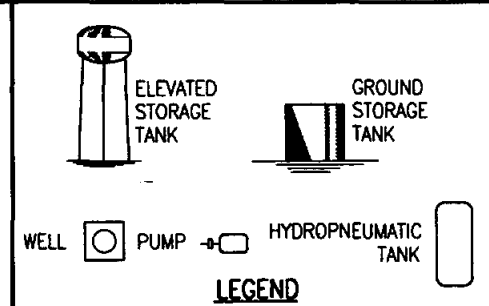

**FIGURE 4.7-1**  
**CITY OF PLEASANTON WATER SYSTEM SCHEMATIC**



Water Wells:	500 connections
Ground Storage:	1000 connections
High Service Pumping:	660 connections
Pressure Maintenance:	1500 connections

The City's existing water supply facilities appear adequate to serve projected population growth through year 2040. Table 4.8-1 presents the water supply facilities projections for the City of Runge. Refer to Figure 4.8-1 for City of Runge Water System Schematic.

TABLE 4.8-1  
CITY OF  
**RUNGE**  
WATER SUPPLY FACILITIES PROJECTIONS

YEAR	PROJECTED POPULATION	PROJECTED CONNECTIONS	PROJECTED PER CAPITA SUPPLY REQUIREMENT (gpcd)	PROJECTED AVG. DAY WATER SUPPLY REQUIREMENT (MGD)	PROJECTED MAX. DAY WATER SUPPLY REQUIREMENT (MGD)	PROJECTED TNRCC WATER SUPPLY REQUIREMENT (MGD)	AVAILABLE WATER SUPPLY (MGD)	ADDITIONAL WATER SUPPLY REQUIREMENT (MGD)	PROJECTED GROUND STORAGE REQUIREMENTS (GALLONS)	ADDITIONAL GROUND STORAGE REQUIREMENTS (GALLONS)	PROJECTED H.S. PUMPING REQUIREMENT (GPM)	ADDITIONAL H.S. PUMPING REQUIREMENT (GPM)	PROJECTED PRES. MAINTENANCE STORAGE REQUIREMENT (GALLONS)	ADDITIONAL PRES. MAINTENANCE STORAGE REQUIREMENT (GALLONS)
<b>TWDB LOW POPULATION PROJECTIONS</b>														
1990	1139	444	129	0.146	0.327	0.383	0.432	0.0	88,800	0.0	888	0.0	44,400	0.0
2000	1190	463	144	0.171	0.383	0.400	0.432	0.0	92,600	0.0	926	0.0	46,300	0.0
2010	1216	473	144	0.174	0.390	0.408	0.432	0.0	94,600	0.0	946	0.0	47,300	0.0
2020	1231	479	144	0.178	0.399	0.414	0.432	0.0	95,800	0.0	958	0.0	47,900	0.0
2030	1251	487	144	0.180	0.403	0.421	0.432	0.0	97,400	0.0	974	0.0	48,700	0.0
2040	1259	490	144	0.181	0.405	0.423	0.432	0.0	98,000	0.0	980	0.0	49,000	0.0
<b>TWDB HIGH POPULATION PROJECTIONS</b>														
1990	1139	444	129	0.146	0.327	0.383	0.432	0.0	88,800	0.0	888	0.0	44,400	0.0
2000	1241	483	144	0.178	0.399	0.417	0.432	0.0	98,600	0.0	966	0.0	48,300	0.0
2010	1283	499	144	0.185	0.414	0.431	0.432	0.0	99,800	0.0	998	0.0	49,900	0.0
2020	1305	508	144	0.187	0.419	0.439	0.432	0.007	101,600	0.0	1016	0.0	50,800	0.0
2030	1333	519	144	0.191	0.429	0.448	0.432	0.016	103,800	0.0	1038	0.0	51,900	0.0
2040	1344	523	144	0.193	0.432	0.452	0.432	0.020	104,600	0.0	1046	0.0	52,300	0.0

1. 2.57 CAPITA PER CONNECTION
2. 2.24 MAX. DAY TO AVG. DAY RATIO
3. 0.432 M.G.D. EXISTING WATER WELL SUPPLY
4. 200,000 GAL. EXISTING GROUND STORAGE CAPACITY
5. 1,320 G.P.M. EXISTING HIGH SERVICE PUMPING CAPACITY
6. 150,000 GAL. EXISTING PRESSURE MAINTENANCE CAPACITY
7. 0.6 G.P.M. PER CONNECTION TNRCC WATER SUPPLY CRITERIA
8. 200 GAL. PER CONNECTION TNRCC GROUND STORAGE CRITERIA
9. 2 G.P.M. PER CONNECTION TNRCC HIGH SERVICE PUMPING CRITERIA
10. 100 GAL. PER CONNECTION TNRCC PRESSURE MAINTENANCE CRITERIA

TABLE 48-1

CITY OF  
**RUNGE**  
 WATER SUPPLY FACILITIES PROJECTIONS

YEAR	PROJECTED POPULATION	PROJECTED CONNECTIONS	PROJECTED PER CAPITA SUPPLY REQUIREMENT (gpcd)	PROJECTED AVG. DAY WATER SUPPLY REQUIREMENT (MGD)	PROJECTED MAX. DAY WATER SUPPLY REQUIREMENT (MGD)	PROJECTED TNRCC WATER SUPPLY REQUIREMENT (MGD)	AVAILABLE WATER SUPPLY (MGD)	ADDITIONAL WATER SUPPLY REQUIREMENT (MGD)	PROJECTED GROUND STORAGE REQUIREMENTS (GALLONS)	ADDITIONAL GROUND STORAGE REQUIREMENTS (GALLONS)	PROJECTED H.S. PUMPING REQUIREMENT (GPM)	ADDITIONAL H.S. PUMPING REQUIREMENT (GPM)	PROJECTED PRES. MAINTENANCE STORAGE REQUIREMENT (GALLONS)	ADDITIONAL PRES. MAINTENANCE STORAGE REQUIREMENT (GALLONS)
<b>TWDB LOW POPULATION PROJECTIONS</b>														
1990	1139	444	129	0.146	0.327	0.383	0.432	0.0	88,800	0.0	888	0.0	44,400	0.0
2000	1190	463	144	0.171	0.383	0.400	0.432	0.0	92,600	0.0	926	0.0	46,300	0.0
2010	1216	473	144	0.174	0.390	0.408	0.432	0.0	94,600	0.0	946	0.0	47,300	0.0
2020	1231	479	144	0.178	0.399	0.414	0.432	0.0	95,800	0.0	958	0.0	47,900	0.0
2030	1251	487	144	0.180	0.403	0.421	0.432	0.0	97,400	0.0	974	0.0	48,700	0.0
2040	1259	490	144	0.181	0.405	0.423	0.432	0.0	98,000	0.0	980	0.0	49,000	0.0
<b>TWDB HIGH POPULATION PROJECTIONS</b>														
1990	1139	444	129	0.146	0.327	0.383	0.432	0.0	88,800	0.0	888	0.0	44,400	0.0
2000	1241	483	144	0.178	0.399	0.417	0.432	0.0	96,600	0.0	966	0.0	48,300	0.0
2010	1283	499	144	0.185	0.414	0.431	0.432	0.0	99,800	0.0	998	0.0	49,900	0.0
2020	1305	508	144	0.187	0.419	0.439	0.432	0.007	101,600	0.0	1016	0.0	50,800	0.0
2030	1333	519	144	0.191	0.429	0.448	0.432	0.016	103,800	0.0	1038	0.0	51,900	0.0
2040	1344	523	144	0.193	0.432	0.452	0.432	0.020	104,600	0.0	1046	0.0	52,300	0.0

1. 2.57 CAPITA PER CONNECTION
2. 2.24 MAX. DAY TO AVG. DAY RATIO
3. 0.432 M.G.D. EXISTING WATER WELL SUPPLY
4. 200,000 GAL. EXISTING GROUND STORAGE CAPACITY
5. 1,320 G.P.M. EXISTING HIGH SERVICE PUMPING CAPACITY
6. 150,000 GAL. EXISTING PRESSURE MAINTENANCE CAPACITY
7. 0.6 G.P.M. PER CONNECTION TNRCC WATER SUPPLY CRITERIA
8. 200 GAL. PER CONNECTION TNRCC GROUND STORAGE CRITERIA
9. 2 G.P.M. PER CONNECTION TNRCC HIGH SERVICE PUMPING CRITERIA
10. 100 GAL. PER CONNECTION TNRCC PRESSURE MAINTENANCE CRITERIA

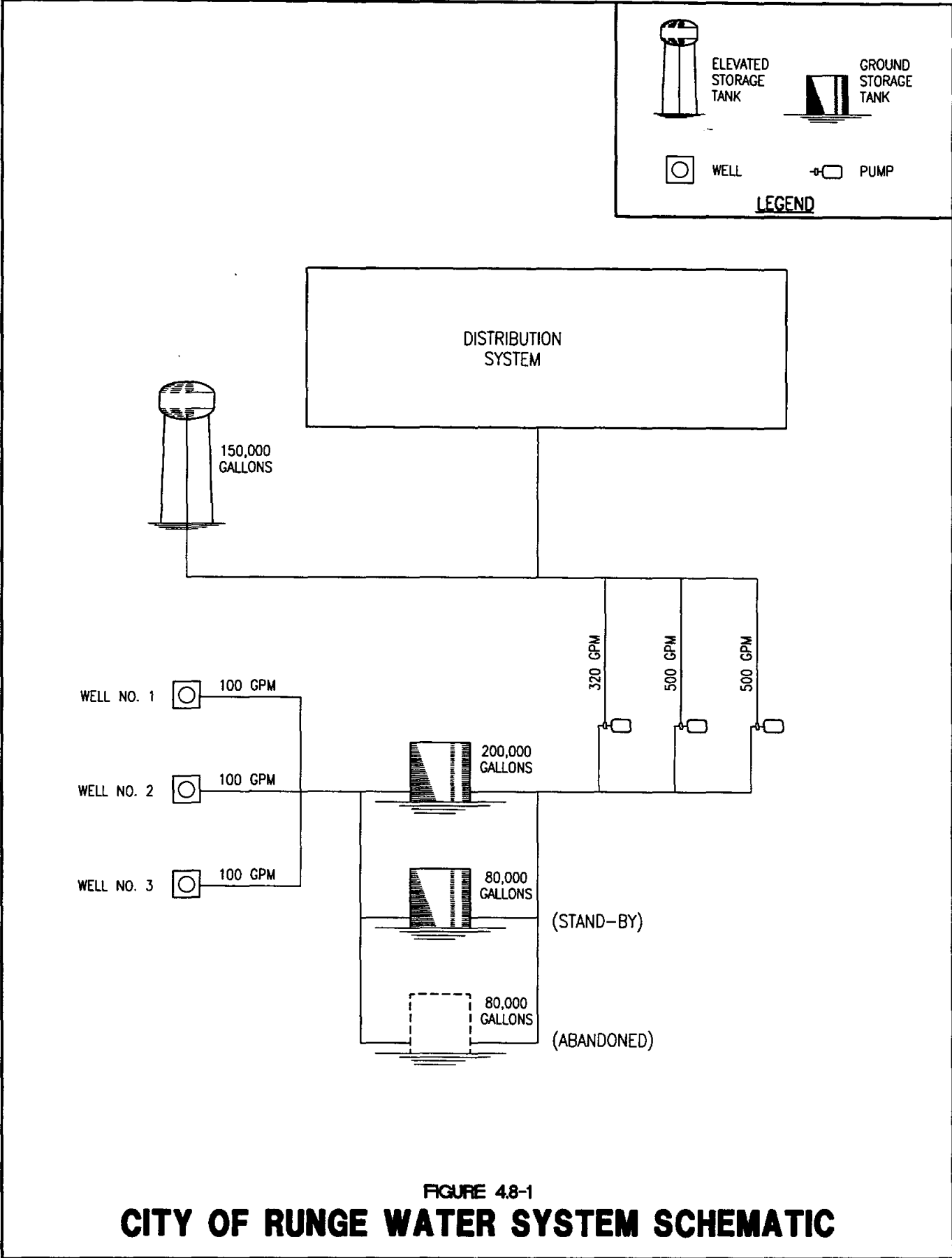

FIGURE 4.8-1  
**CITY OF RUNGE WATER SYSTEM SCHEMATIC**

#### 4.9 OTHER NON PARTICIPATING WATER PURVEYING ENTITIES

The participating municipalities are large water users in the AACOG project area; however, the majority of water use in Atascosa, Frio, Karnes and Wilson Counties can be attributed to other non-participating water purveying entities.

The water purveying entities with Certificates of Convenience and Necessity (CNN) are shown in Figure 4.9-1 for Atascosa County, Figure 4.9-2 for Frio County, Figure 4.9-3 for Karnes County, and Figure 4.9-4 for Wilson County.

There are a total of sixteen (16) water purveying entities in Atascosa County while only one, the City of Pleasanton, is participating in this project. Frio County has four (4) water purveying entities with only one, the City of Pearsall, participating in this study. Karnes County has eight (8) water purveying entities with four, the cities of Falls City, Karnes City, Kenedy and Runge, participating in this study. Finally, Wilson County has fifteen (15) water purveying entities and only one, the City of Floresville, participating in this study.

A list of all water purveying entities for each county is given in Table 4.9-1.

**TABLE 4.9-1  
LIST OF ALL WATER PURVEYING ENTITIES IN  
ATASCOSA, FRIO, KARNES, AND WILSON COUNTIES**

<u>ATASCOSA COUNTY</u>	<u>CCN NUMBER</u>
Benton City WSC	12587
Calico Water Works, Inc.	12023
Campbellton Water Works, Inc.	12581
Charlotte, City of	—
Eastlake Subdivision Water Works	12588
Fashing-Peggy WSC	10648

**TABLE 4.9-1  
(continued)**

<b><u>ATASCOSA COUNTY</u></b> <b>(continued)</b>	<b><u>CNN NUMBER</u></b>
Hickory Water Works	11869
Jourdanton, City of	12039
Lytle, City of	11007
McCoy WSC	10649
Pleasant Oaks Development Corp.	12266
Pleasanton, City of	—
Poteet, City of	20268
Raggedy Acres WSC	12246
Water Services III	10650
Windy's Water Works, Inc.	10641
 <b><u>FRIO COUNTY</u></b>	
Benton City WSC	12587
Dilley, City of	—
Moore WSC	10212
Pearsall, City of	10237 and 20094
Yancey WSC	11463
 <b><u>KARNES COUNTY</u></b>	
El Oso	10570
Falls City, City of	10719
Fashing-Peggy WSC	10648

**TABLE 4.9-1  
(continued)**

<b><u>KARNES COUNTY</u></b> <b>(continued)</b>	<b><u>CNN NUMBER</u></b>
Karnes City, City of	11258
Kenedy, City of	20308
Runge, City of	—
Sunko WSC	10658
Three Oaks WSC	10656
 <b><u>WILSON COUNTY</u></b>	
Calico WSC	12023
C Willow Water Co.	12240
Eagle Creek Ranch Water Co.	12275
El Oso WSC	10570
Floresville, City of	10668
Hickory Hill Water Co., Inc.	12116
Lake Valley Water Co., Inc.	12308
La Vernia, City of	20280
Oak Hills WSC	10647
Poth, City of	20276
Shady Oaks Water Co., Inc.	12090
SS WSC	11489
Stockdale	20289
Sunko WSC	10658
Three Oaks WSC	10656

Figure 4.9.1

Water Purveying Entities  
in Atascosa County

Map Scale: 1" = 16 miles

Legend:  
- - - - - County Boundary  
- - - - - City Boundary  
- - - - - Water Purveying Entity Boundary  
- - - - - Water Purveying Entity Name

- CCN - ATASCOSA CO. UTILITY
- 10841 - Brady Water Works Inc
- 10848 - Fishing - Pege WSC
- 10849 - M-Op WSC
- 10850 - Water Services I, Inc
- 10855 - Pecos City of
- 10859 - Hickory Water Works
- 12023 - Calico Water Supply Inc
- 12029 - Foundation City of
- 12246 - Blagney Acres WSC
- 12248 - Pecos Valley WSC
- 12568 - Campbellton Water Works Inc
- 12569 - Bastion City WSC
- 12568 - Bastion Subd. Water System
- 12028 - Pecos City of

Regional Data Center

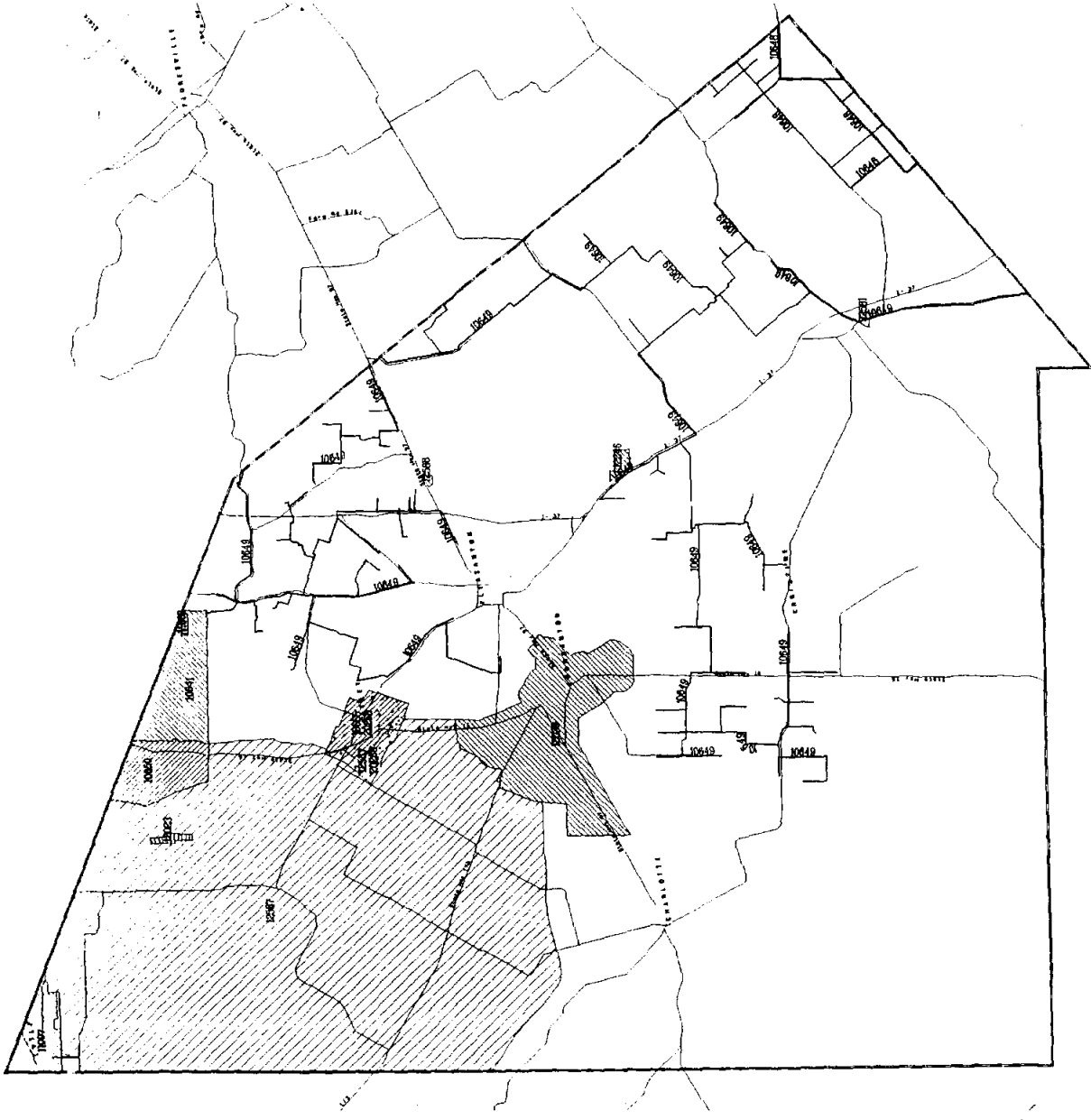









## 5.0 FUTURE WATER SUPPLY NEEDS

### 5.1 WATER SUPPLY

Water supply has been tabulated for each of the participating municipalities in Section 2.0. However, the four county study area includes many water purveying entities that did not participate in this study.

Figures 4.9-1, 4.9-2, 4.9-3, and 4.9-4 show the existing certificated service area for each water purveying entity in Atascosa, Frio, Karnes, and Wilson Counties respectively.

A preliminary search of records from the Texas Water Development Board and the Texas Natural Resource Conservation Commission provided water use data for most of the water purveying entities in the AACOG study area. This data is tabulated in Table 5.1-1 and water use is projected through the study period. This table illustrates that the nonparticipating water purveying entities constitute a significant portion of total water use in each county. The water source for each entity is essentially the same as the nearby participating municipalities.

County wide water use projections were previously shown in Table 2.4-1. In comparing the water supply needs of each participating municipality to the county wide water use projections based upon the high population projection, the following percentages are obtained for design year 2020:

Falls City	4.8%	Pearsall	60.8%
Floresville	23.6%	Pleasanton	26.1%
Karnes City	18.8%	Runge	7.8%
Kenedy	32.3%		

**TABLE 5.1-1**

**Water Usage of All Water Purveying Entities in MGD  
For AACOG Project Area  
(Based Upon High Population Projection and High Water Use w/o Conservation)**

<b>ATASCOSA COUNTY</b>	<b>1990</b>	<b>2000</b>	<b>2010</b>	<b>2020</b>	<b>2030</b>	<b>2040</b>
Benton City WSC	-0-					
Calico Water Supply, Inc.	*					
Campbellton Water Works, Inc.	*					
Charlotte, City of	0.220	0.378	0.425	0.463	0.504	0.526
Eastlake Subdivision Water Works	*					
Fashioning Peggy WSC	0.060					
Hickory Water Works	*					
Jourdanton, City of	0.598	0.889	1.036	1.152	1.263	1.376
Lytle, City of	0.493					
McCoy WSC	0.326					
Pleasanton Oaks Development Corp.	*					
Pleasanton, City of	1.389	1.702	1.979	2.211	2.435	2.659
Poteet, City of	0.942	1.103	1.229	1.335	1.436	1.538
Raggedy Acres WSC	*					
Water Services III	*					
Windy's Water Works, Inc.	**					

**TABLE 5.1-1  
(cont.)**

<b>FRIO COUNTY</b>	<b>1990</b>	<b>2000</b>	<b>2010</b>	<b>2020</b>	<b>2030</b>	<b>2040</b>
Benton City WSC	***					
Dilley, City of	0.590	0.690	0.781	0.833	0.891	0.924
Moore WSC	0.030					
Pearsall, City of	1.430	1.600	1.914	2.134	2.394	2.505
<b>KARNES COUNTY</b>	<b>1990</b>	<b>2000</b>	<b>2010</b>	<b>2020</b>	<b>2030</b>	<b>2040</b>
El Oso WSC	0.998					
Falls City, City of	0.091	0.108	0.112	0.115	0.118	0.119
Fashing-Peggy WSC	***					
Karnes City, City of	0.366	0.420	0.440	0.451	0.464	0.470
Kenedy, City of	0.609	0.725	0.758	0.775	0.795	0.804
Runge, City of	0.146	0.179	0.185	0.187	0.191	0.193
Sunko WSC	****					
Three Oaks	****					
<b>WILSON COUNTY</b>	<b>1990</b>	<b>2000</b>	<b>2010</b>	<b>2020</b>	<b>2030</b>	<b>2040</b>
Calico WSC	*					
C Willow Water Co.	*					
Eagle Creek Ranch Water Co.	0.010					
El Oso WSC	****					
Floresville, City of	0.932	1.228	1.497	1.670	1.823	1.961

**TABLE 5.1-1  
(cont.)**

<b>WILSON COUNTY (continued)</b>	<b>1990</b>	<b>2000</b>	<b>2010</b>	<b>2020</b>	<b>2030</b>	<b>2040</b>
Hickory Hill Water Co., Inc.	*					
Lake Valley Water Co., Inc.	0.003					
La Vernia, City of	0.176					
Oak Hills WSC	0.293					
Poth, City of	0.322	0.441	0.492	0.526	0.554	0.581
Shady Oaks Water Co., Inc.	0.016					
SS WSC	0.606					
Stockdale	0.244	0.307	0.338	0.372	0.410	0.436
Sunko WSC	0.340					
Three Oaks	0.168					

- \* RECORDS NOT FOUND
- \*\* SEE BEXAR COUNTY
- \*\*\* SEE ATASCOSA COUNTY
- \*\*\*\* SEE WILSON COUNTY

The four participating municipalities in Karnes County account for almost 64% of total county wide water use.

Of the seven participating municipalities only three are projected to need additional water supply prior to 2020. Table 5.1-2 illustrates the high projected water use for each participating municipality.

The previous tables only illustrate projected water use or "water need" on the basis of quantity. When water quality is examined, three participating municipalities are highlighted which own water supplies that would not meet state and federal drinking water standards without treatment or mixing with higher quality water. These three municipalities are located in Karnes County and include Karnes City, Kenedy, and Runge. Karnes City currently meets drinking water standards by mixing water with a Carrizo water source purchased through the El Oso Water Supply Corporation. Kenedy is in the process of implementing Reverse Osmosis Treatment to meet drinking water standards. Runge is procuring funding and planning a new water well with higher quality water to mix with existing well water to meet water quality standards.

**TABLE 5.1-2**

**ADDITIONAL WATER SUPPLY (MGD) REQUIRED  
BASED ON HIGH POPULATION AND WATER USE PROJECTION**

	Existing Water Supply	2000	2010	2020	2030	2040
Falls City	2.016	-0-	-0-	-0-	-0-	-0-
Floresville	5.112	-0-	-0-	-0-	-0-	-0-
Karnes City	1.479	-0-	-0-	-0-	-0-	-0-
Kenedy	3.035	-0-	-0-	-0-	-0-	-0-
Pearsall	6.552	-0-	-0-	0.191	1.013	1.384
Pleasanton	4.853	-0-	-0-	0.033	0.528	1.023
Runge	0.432	-0-	-0-	0.007	0.016	0.020

**5.2 WATER SUPPLY FACILITIES**

Water supply facilities for the participating municipalities include groundwater wells and ground storage tanks. An inventory of the existing water supply facilities was presented in Section 4. In evaluating the future need for water supply facilities, two components must be examined: 1). the future need based upon growth, and, 2). the necessity of facility replacement due to age and component failure. It is assumed in this report that a water well and a ground storage tank will have a design life of 50 years when given appropriate maintenance.



Table 5.2-1 illustrates the projected ground storage requirements of each municipality. As can be seen from this table, only the City of Floresville is projected to need additional ground storage facilities beginning prior to year 2020.

**TABLE 5.2-1**

**ADDITIONAL GROUND STORAGE REQUIREMENTS (GALLONS)  
BASED UPON HIGH POPULATION AND WATER USE PROJECTION**

	Existing Ground Storage Capacity	<u>2000</u>	<u>2010</u>	<u>2020</u>	<u>2030</u>	<u>2040</u>
Falls City	165,000	-0-	-0-	-0-	-0-	-0-
Floresville	615,000	-0-	-0-	63,600	125,000	181,800
Karnes City	431,000	-0-	-0-	-0-	-0-	-0-
Kenedy	660,000	-0-	-0-	-0-	-0-	-0-
Pearsall	1,275,000	-0-	-0-	-0-	-0-	-0-
Pleasanton	1,760,000	-0-	-0-	-0-	-0-	-0-
Runge	200,000	-0-	-0-	-0-	-0-	-0-

Replacement of failed water supply facilities presents substantially higher projections. Table 5.2-2 estimates the water supply facilities of each participating municipality that will probably require replacement prior to year 2020.

**TABLE 5.2-2**

**PROJECTED WATER FACILITY REPLACEMENT  
PRIOR TO YEAR 2020**

	<u>Water Wells</u> (GPM)	<u>Ground Storage Capacity</u> (GALLONS)
Falls City	700	165,000
Floresville	750	275,000
Karnes City	570	-0-
Kenedy	1278	-0-
Pearsall	1950	275,000
Pleasanton	1560	60,000
Runge	200	-0-

Each participating municipality should establish new water supply and facilities to replace failed water wells and ground storage tanks with additional or rated capacities to meet future water use projections. Table 5.2-3 estimates the new water supply and ground storage capacities that each participating municipality will need to establish by design year 2020.

**TABLE 5.2-3**

**ESTIMATED NEW WATER SUPPLY AND  
GROUND STORAGE CAPACITY NEEDED TO MAINTAIN  
TNRCC RATED CAPACITY THROUGH DESIGN YEAR 2020**

	<u>Water Wells</u>	<u>Ground Storage Capacity</u>
Falls City	Min.126 gpm	Min. 60,000
Floresville	-0-	Min. 350,000
Karnes City	Min.316 gpm	-0-
Kenedy	Min.191 gpm	-0-
Pearsall	Min.2083 gpm	-0-
Pleasanton	Min.1583 gpm	-0-
Runge	Min.205 gpm	-0-

Furthermore, it can be anticipated that most of the existing water wells and ground storage tanks in the participating municipalities will require replacement prior to year 2040.

**6.0 SCREENING OF ALTERNATIVE WATER SUPPLY SOURCES**

**6.1 GENERAL**

In Section 2.0 water use projections indicated a steady increase in water consumption in the four county AACOG project area by the participating municipalities. Furthermore, assuming a 50 year life for wells, many water wells belonging to the participating municipalities will fail prior to planning year 2020. The increase in demand coupled with replacement of failed wells must be met from existing or new sources of water. In addition, water quality must be taken into account to meet state and federal drinking water quality standards.

Atascosa, Frio, Karnes, and Wilson Counties are fortunate to have alternative water supplies available during the planning period. This section will identify and screen these alternatives and make recommendations for these evaluations.

**6.2 GROUNDWATER**

Abundant groundwater resources will continue to be available to the cities in the AACOG project area. Even if future water demands exceed standard projections and water-level declines are significantly greater than predicted, the aquifers beneath the AACOG Project area will likely still be able to supply sufficient water beyond 2020 in most instances.

Though the quantity of water available is abundant, each participating city will be faced with issues, concerns, and decisions in attempting to optimize groundwater supplies. Well construction, pump settings, water quality, and water treatment are potential questions that cities may likely face.

The following provides general evaluations, projections, and possible options for each participating City, based on information from state reports and files, and some data provided from each city. Evaluations of the groundwater supply for each city includes background information, projections for future demands, and possible alternatives for meeting demands.

Each City should conduct detailed evaluations to determine the most effective means by which to

meet future water supply requirements.

## **6.2.1 City of Falls City - Karnes County**

### Background

Located in western Karnes County and very close to the Karnes-Wilson counties boundary, Falls City obtains its public water supply from the Carrizo Aquifer. Reportedly, Falls City obtains its water from one deep (3564 ft.) Carrizo well that flows about 700 gpm (1.0 MGD). A second well is under construction, and Falls City file notes indicate that it is expected to flow about the same amount. Water usage reported by the TWDB during 1990 was about 0.09 MGD, or an average demand rate of about 63 gpm. Peak day demands were of 0.235 MGD (163 gpm).

The existing Falls City well is reported to be 3564 feet deep, with the top of the screened interval at 3494 feet below ground level. Reportedly, 10-inch casing was set to 403 feet below ground level, so a 9-inch pump could be set to almost that depth if needed. Water levels have not been lowered significantly in the area.

As previously discussed , Falls City lies atop the "bad water line" for the Carrizo Aquifer. Immediately down dip, water exceeds drinking water standards for TDS and possibly other constituents. Historical records as of 1972 indicate that Falls city water met all drinking water standards, though some slight iron problems were evident. However, due to the vicinity of Falls City to the "bad water line", long-term regional water-level declines in the Carrizo could possibly negatively impact water quality in the City's wells.

### Projections

TWDB projections indicate that Falls City will need to produce an average of about 0.12 MGD (80 gpm) by 2020. Water-level declines should be slight based on the assumptions of only TWDB increases regionally. The Carrizo Aquifer and likely existing Falls City wells should be able to supply more than sufficient water throughout the planning period. With appropriate addition of pumps and/or additional wells, the Carrizo will likely provide Falls City with sufficient water for

longer than the planning period.

### Options

1. Existing wells will provide more than enough water throughout the planning period. Setting of pumps and treatment may be required as regional water levels continue to decline.
2. Drill wells updip - If property could be obtained and suitable sites located, wells could be drilled in Wilson County, updip from Falls City. This would allow for shallower wells and possibly better quality water, especially if the "bad-water line" is drawn toward the Falls City wells. However, pumps would likely be needed as updip wells may not flow.
3. Wells south of Falls City - Wells could be located south of the City, in the Catahoula Formation. Wells would be much shallower, but yields would be much smaller. Also, the quality of Catahoula water is quite variable, and can be poor even in updip portions of the aquifer.

### **6.2.2 City of Floresville - Wilson County**

#### Background

The City of Floresville is located in central Wilson County, about 25 miles northeast of Pleasanton. It is reported that Floresville obtains all of its water supply from wells completed in the Carrizo Aquifer. The Carrizo is very productive in Wilson County, with transmissivities as high as 300,000 gpd/ft.

City records indicate that three wells are used, two capable of pumping about 1,300 gpm, and one about 750 gpm for a combined total of 3,350 gpm (4.82 MGD). Pumpage records from the TWDB show that Floresville pumped slightly over 0.93 MGD (647 gpm) during 1990. Peak day demand pumping rates were 2.21 MGD (1534 gpm).

Records indicate that the Floresville wells have high specific capacities of up to 48 gpm/ft. No

current water levels were available, but based on 1970 to 1982 water levels, current water levels are probably less than 50 feet below ground level. Pumps are set from 110 to 170 feet below ground level. Water level declines from 1970 to 1982 were only 13 feet, or about 1 foot per year, according to available TWDB data.

Carrizo water near Floresville is more highly mineralized than near Pearsall and Pleasanton. Historical records show that some wells may have chloride and TDS concentrations near drinking water standard limits; however, most analyses indicated suitable drinking water. Some slightly high iron concentrations might occur. In addition, the water is very hard, with hardness concentrations of over 160 mg/L. Oxidation, sequestering, softening, or other treatment might be necessary.

### Projections

The TWDB projected during the 1970's that the Floresville area would be a favorable area for more Carrizo pumpage. Even with large water level declines (i.e. 10 feet per year), the Carrizo will likely be able to supply Floresville with sufficient water for its public supply demands. Pumps may need to be lowered in existing wells in later years, if possible. Additional or newly constructed replacement wells with appropriately deep pump settings would allow Floresville to obtain sufficient Carrizo water for its needs.

### Options

1. Existing well field will provide more than enough water throughout the planning period, assuming TWDB projections, no well failures due to mechanical problems, and that pumps can be lowered if necessary.
2. Wilcox wells - Wilcox wells could provide significant water, but water would be more highly mineralized and would probably require treatment.
3. A few miles northwest of Floresville, Carrizo-Wilcox wells provide suitable water for public supply. Pipeline costs could be significant.

4. Queen City wells - Floresville is in the Queen City outcrop. Smaller capacity wells could be located in the outcrop and slightly south of town in artesian portions of the aquifer.

### **6.2.3 Karnes City - Karnes County**

#### **Background**

Karnes City is located in central Karnes County. City records indicate that Karnes City obtains most of its public supply from the El Oso Water Supply Corporation, which uses at least one Carrizo well located in Wilson County, about 2.8 miles northwest of Falls City. Karnes City also has three wells that are apparently only operated as standby wells. Records indicate that the Karnes City wells are completed in the Catahoula Formation.

Records for one of the El Oso WSC wells state that the well was flowing about 1000 gpm (1.4 MGD) in 1980, and that a pump is set at 300 feet below ground level. No pumping history was available for the Catahoula wells, but information from available reports indicates that pumping rates of 200 to 300 gpm (0.3 to 0.4 MGD) are probably reasonable. TWDB water usage records show that Karnes City was supplied an average of 254 gpm (0.37 MGD) during 1990. Demands during peak day pumpage were 0.763 MGD (530 gpm). Records indicate that water-level declines in the Carrizo wells in Wilson County and in the Catahoula wells in Karnes City have been small.

According to available records, water from the Karnes City Catahoula wells exceeds drinking water standards for total dissolved solids, chloride, and fluoride. This water should be treated or mixed with other water to lower these constituents below drinking water standards. Records for the El Oso WSC Carrizo well indicates that the well produces water containing high iron and manganese concentrations and having odor due to hydrogen sulfide. Total dissolved solids concentrations are slightly below the secondary drinking water standard.

#### **Projections**

Water usage projections from the TWDB predict that Karnes City will require about 313 gpm (0.45 MGD) by the year 2020. Even with very large water level declines, Carrizo wells north of Falls City

will likely be able to provide Karnes City with sufficient water throughout the planning period. Large water-level declines could possibly lead to deterioration of Carrizo water quality near the El Oso wells, as these wells are near the Carrizo "bad-water line".

### Options

1. Present supply will yield enough water for the planning period, depending on the total supply that El Oso WSC must supply to other users. Some treatment may be necessary.
2. New wells near Karnes City - It is possible that enough suitable sites could be located for wells to be completed in either the Catahoula formation, or in the outcrop area of the Oakville Sandstone. Though the City's Catahoula wells yield poor quality water, some nearby Catahoula wells provide suitable drinking water. Oakville Sandstone wells yield suitable water, but would probably need to be located down dip slightly, requiring some pipeline construction. Catahoula and Oakville wells typically produce 200 to 500 gpm, according to historical records.
3. Pump existing Catahoula wells and treat water.
4. Obtain property in Wilson County and drill Carrizo wells. One productive Carrizo well should produce around 1000 gpm. With one standby well, the City's needs would be met.

### **6.2.4 City of Kenedy - Karnes County**

The City of Kenedy is located in south-central Karnes County, about 6 miles southeast of Karnes City. Kenedy owns 7 wells, but operates only 5 wells to supply its public water supply needs. Apparently, one well is not used due to high chloride and total dissolved solids concentrations, and one well is under construction. State records indicate that one well is constructed in the Oakville Sandstone. Furnished City files indicate that wells are complete in the Catahoula Formation. It is possible that some wells are completed in each of the units, or both. The Oakville Sandstone has slightly higher transmissivity than the Catahoula (i.e. 14,000 gpd/ft vs. 5,000 gpd/ft).



Individual well pumping rates reportedly average about 280 gpm, and the total obtainable pumpage from the 5 utilized wells is 1385 gpm (2.0 MGD). If all seven wells are utilized, the City estimates that about 2108 gpm (3.03 MGD) can be pumped. 1990 TWDB records show that Kenedy supplied about 0.6 MGD (420 gpm) of water from its wells. City notes show the highest monthly total during 1993 was 750 gpm (1.1 MGD). Water levels have apparently declined very little since the 1960's, according to state records.

All wells produce highly mineralized water with chloride and total dissolved solids concentrations approaching twice the secondary drinking water limits. It is apparent from City records that Kenedy is beginning treatment of the well water by reverse osmosis.

### Projections

Projections from TWDB predict that Kenedy will need about 0.78 MGD (538 gpm) of water by the year 2020. Water level declines should continue to be minimal, as the producing aquifers are not heavily pumped, however, new detailed study is needed to confirm this projection. The Catahoula and Oakville Sandstone Aquifer will likely be able to supply water demands to Kenedy throughout the planning period. Additional wells and/or appropriate lowering of pumps may be necessary. Kenedy will need to continue treatment of its groundwater.

### Options

1. Utilize existing system with Reverse Osmosis or other effective methods of applicable water treatment.
2. Replace existing wells with more appropriately constructed wells at more suitable sites, if accessible and available.
3. Locate suitable sites in the Catahoula and Oakville Sandstone Aquifers, test drilling for better quality water and productive sites. This would require additional pipeline construction.

## 6.2.5 Pearsall - Frio County

### BACKGROUND

The City of Pearsall, located in central Frio County, obtains its public water supply from wells completed in the Carrizo Aquifer. The Carrizo is highly productive in the area, with transmissivities as high as 230,000 gpd/ft.

Pearsall reports using 4 wells that are capable of pumping a total of about 4,550 gpm (6.5 MGD) with present pumping equipment at present settings and at present water levels. During 1990, water usage for Pearsall as reported to the TWDB was about 1.4 MGD, or almost 1,000 gpm continuously. Peak day pumping rates were as high as 4.512 MGD.

Individual wells are highly productive, with current pumping rates of up to about 1300 gpm. Records indicate that specific capacities in Pearsall wells range from about 20 to 40 gpm/ft. While records for each well were not available, notes from Pearsall files indicate that water levels are currently at about 330 feet below ground level, while pumps are set at about 500 to 600 feet below ground level. Based on reported approximate static water levels and average specific capacities, pumping water levels are about 100 to 250 feet above pump settings. Water levels declined between 1970 and 1991 by only about 30 feet in Pearsall wells, according to TWDB data.

Carrizo water near Pearsall generally meets primary and secondary drinking water standards. High iron concentrations may occur, but may be treated by oxidation or sequestering. Also, historical water-quality records indicate that Carrizo water is extremely hard near Pearsall.

### Projections

The Carrizo Aquifer has been heavily developed regionally primarily due to large amounts of irrigation pumpage. However, the Carrizo is a large, prolific aquifer and is capable of yielding large quantities of water. Current static water levels are about 750 to 1,000 feet above the top of the Carrizo, however, pump settings are currently quite shallow.

High TWDB water use projections show that Pearsall will require about 2.13 MGD, or about 1,468 gpm, of water by the year 2020. Pearsall can reportedly pump about 4,550 gpm with present conditions.

If water-levels decline at rates equal to the last 20 years, water levels would probably decline by about 50 feet by 2020. However, as pumpage increases, water level decline rates will increase. The actual decline rate cannot be estimated without further careful evaluation of past regional pumpage and historical water levels. Based on TWDB modeling and general future projections, water-level declines of 100 feet between 1993 and 2020 are possible. By lowering pump settings, or by constructing wells so that pumps can be set lower as applicable, Pearsall should be able to meet predicted water demands throughout the planning period using wells constructed in the Carrizo Aquifer.

### Options

1. Pump existing wells - The existing wells will produce more water than the 2020 projection of 2.13 MGD (1468 gpm). If well construction allows, pumps may need to be lowered as water levels decline. Even based on high water-level decline rates (i.e. 10 feet per year), pumping levels in wells would remain as much 500 feet above the top of the aquifer by the year 2020.
2. Replace existing wells - Construct wells so that large capacity pumps can be set deep enough to allow for significant water level declines and still have enough submergence to produce the amounts needed.
3. Add more Carrizo wells - One to two wells could be added at 1300 to 1500 gpm each or more, if suitable locations and sites were available. Interference drawdowns would not limit such additional wells, if spaced appropriately.
4. Wilcox wells - No water quality records were available for Wilcox wells near Pearsall, but some wells apparently completed in the Carrizo and Wilcox reportedly provided suitable drinking water. Transmissivities in the Wilcox are lower than the Carrizo in the area, but the

depth of the aquifer would provide for more available drawdown. If the water quality of the Wilcox is marginal, the water could possibly be mixed with Carrizo water or minor treatment could be utilized.

#### **6.2.6 City of Pleasanton - Atascosa County**

##### Background

The City of Pleasanton, located in north central Atascosa County, obtains all of its water from 9 wells. Reportedly, eight wells are completed in the Queen City Aquifer, while one well is a Carrizo well. The Queen City has lower transmissivities than the Carrizo; however, both are productive aquifers. Queen City transmissivities range from about 10,000 to 30,000 gpd/ft, while Carrizo transmissivities are typically over 150,000 gpd/ft.

Pleasanton wells are reportedly capable of pumping a total of about 3,370 gpm (4.85 MGD) presently. Pumping rates for the Queen City wells are typically between 250 and 500 gpm and specific capacities appear to range from 10 to 15 gpm/ft. Pumps are reported to be set at depths ranging from 170 to 300 feet below ground level, and static water levels are about 70 to 100 feet below ground level. Based on specific capacities, reported rates, pump settings, and static water levels, pumping water levels are about 50 to 150 feet above pumps. Tops of screened intervals are from 600 to 650 feet below ground level. TWDB water-level data indicate that water usage records show that Pleasanton pumped about 1.39 MGD (965 gpm). Peak day rates were about 3.070 MGD (2132 gpm).

Pleasanton wells could experience some water-quality problems such as high iron, manganese, and hydrogen sulfide concentrations. It appears that Queen City wells produce slightly higher mineralized water than Carrizo wells near Pleasanton. Historical records show water quality meeting primary and secondary drinking water standards. Iron or manganese problems or hydrogen sulfide problems can usually be easily treated.

## Projections

TWDB projections for 2020 indicate that Pleasanton will need an average of 2.21 MGD, or about 1,535 gpm. Pleasanton's wells can supply currently peak demands up to 4.85 MGD. Even with unreasonably large water level declines during the next 30 years (i.e. 10 feet per year), water levels would still be over 200 feet above the screened intervals in wells in the year 2020. Therefore, with properly modified existing wells or additional wells, the Queen City Aquifer should provide sufficient water for Pleasanton to meet its water-supply demands. In addition, Carrizo wells could be used to provide additional water.

## Options

1. Pump existing wells - The existing wells will likely provide sufficient water for many years, barring mechanical or well construction failure. If well construction allows, pumps may require lowering as water levels decline.
2. Replace existing wells - Existing wells could be replaced with larger capacity wells, or wells of the same size as existing wells, making sure that well dimensions allow for lowering pumps in the future to levels near the tops of screened sections.
3. Carrizo wells - While the Carrizo is pumped heavily nearby for irrigation purposes, water level declines have been relatively minor and small. Carrizo wells, while deeper, would have shallow pumping water levels and would provide for more long term available drawdown. The Carrizo is also more productive than the Queen City, and very large pumping rates are possible.

### **6.2.7 City of Runge - Karnes County**

#### Background

The City of Runge is located in eastern Karnes County and is the easternmost City in the area of consideration. Runge obtains its public water supply from water wells completed in the Oakville

Sandstone aquifer. Aquifer tests in Oakville wells indicate that the formations transmissivity ranges from about 8,000 gpd/ft to 16,000 gpd/ft.

Runge operates three wells ranging in depth from about 150 to 210 feet. Reportedly, these wells can pump about 100 gpm each, or a total of 300 gpm (0.4 MGD). The TWDB reports that Runge supplied an average of about 100 gpm (0.15 MGD) during 1990. Peak day production rates were 0.327 MGD (227 gpm). Available reports indicate that water levels in nearby Oakville wells have only declined by a few feet since 1953.

Furnished records indicate that the Runge wells produce suitable quality water, except for chloride concentrations in excess of secondary drinking water standards. Total dissolved solids concentrations also are near drinking water standards.

### Projections

TWDB projections predict that Runge will need to provide about 130 gpm (slightly less than 0.2 MGD) by the year 2020. The Oakville Sandstone will likely be able to supply appropriately designed wells with sufficient water to meet Runge demands through 2020. With proper maintenance, the Runge wells can likely supply the needed amounts through the planning period. Appropriate treatment of the groundwater may be necessary.

### Options

1. Utilize existing wells with proper maintenance.
2. Drill additional well in the Oakville Sandstone. Deeper wells could be located south of Runge, so that wells could be constructed deeper and provide more available drawdown. Test drilling would be necessary to locate suitable sites in terms of aquifer productivity and water quality.

### 6.3 SURFACE WATER

Surface water is not readily available to the participating municipalities. The nearest existing reservoir to the AACOG project area is Choke Canyon Reservoir located in Live Oak and McMullen Counties on the Frio River. Choke Canyon Reservoir primarily is utilized as a water supply for the City of Corpus Christi. The water rights for Choke Canyon Reservoir and the Frio River have been adjudicated, and none of the participating municipalities have obtained surface water rights from this source.

Current holders of water rights from Choke Canyon Reservoir are listed in Table 6.3-1:

**Table 6.3-1  
Choke Canyon Reservoir Water Rights Holders**

River Order Number	Authorities	<u>Acre.Ft</u>	<u>Use</u>
1255000000	City of Corpus Christi	200	Irrigation
"	"	500	Municipal
"	Texas Parks & Wildlife Dpt.	60	Irrigation
"	City of Corpus Christi	78,530	Industrial
"	Texas Parks & Wildlife Dpt.	50	Domestic
"	City of Corpus Christi	<u>59,770</u>	Municipal

Total 139,110 Acre.Ft.

The City of Corpus Christi currently operates a Water Treatment Plant on Lake Corpus Christi Approximately thirty-nine (39) miles downstream from Choke Canyon Reservoir. The City of Corpus Christi serves other municipalities in route to Corpus Christi including Three Rivers, Mathis and Beeville. The possibility exists that the City of Corpus Christi could be able to serve certain municipalities in the AACOG project area should additional water treatment facilities ever be constructed along Choke Canyon Reservoir.

Other major reservoirs are planned for construction near the AACOG project area. Construction will be dependent upon financing probably from a large municipality such as San Antonio or Corpus Christi. Alternatively, financing may be procured by the applicable River Authority responsible for the reservoir. Figure 3.2-1 illustrates the existing and proposed reservoirs near the AACOG project area.

Possible future reservoirs include the Lindenau and Cuero Reservoirs in the Guadalupe River Basin and the Goliad and Cibolo Reservoirs in the San Antonio River Basin. The Lindenau, Cuero, and Goliad reservoir sites are projected for development within the planning period (prior to the year 2040). However, the Cibolo Reservoir probably will not be needed within the planning period due to the projected water conservation of the City of San Antonio. All of these reservoirs are planned to meet the water supply needs of the City of San Antonio.

It appears that should surface water become available during the planning period, the participating municipalities must join the City of San Antonio or the City of Corpus Christi in the development of this resource. The most probable course for procuring water supply would be to buy water from the applicable metropolitan city after treatment and tap into the transmission system carrying potable water from the source to the metropolitan user.

#### **6.4 RECOMMENDED ALTERNATIVES FOR FURTHER EVALUATION**

Alternatives for water supply in the AACOG project area fall into three categories. These categories are labeled:

- \* Individual expansions utilizing groundwater
- \* Regional Expansions utilizing groundwater
- \* Regional Expansions utilizing surface water

##### **6.4.1 Individual Expansion Utilizing Groundwater**

Each of the municipalities participating in this study has its own groundwater supply, treatment, and distribution system. Previous sections have illustrated that each individual municipality can



accommodate its own growth and projected water demand through the planning period. This alternative should be evaluated by comparative cost-effective analysis.

#### **6.4.2 Regional Expansion Utilizing Groundwater**

The participating municipalities in conjunction with currently nonparticipating municipalities and other water purveying entities could effectively combine resources and infrastructure to provide water supply, treatment and distribution to adjoining areas.

Three regions have been identified which may sustain and improve collected water facilities. These regions are identified in Table 6.4-1 and include water use projections based upon High Population Projections for years 2020 and 2040. This alternative should be examined by comparative cost-effective analysis.

#### **6.4.3 Regional Expansion Utilizing Both Groundwater and Surface Water**

This alternative would be essentially the same as item 6.4.2 except adding surface water as a water source to increase total water supply currently obtained from groundwater. This alternative would be dependent upon obtaining a water supply contract probably with either Corpus Christi or San Antonio or both. Because this alternative requires the infrastructure of the item 6.4.2 alternative and the construction of dams and reservoirs, it is very apparent that it will be the most costly. Therefore a cost comparison analysis will not be performed. The participating municipalities should note this alternative and consider surface water supply if and when it becomes available.

**TABLE 6.4-1**

**WATER USE PROJECTION FOR REGIONAL WATER SYSTEMS**

	<u>1990</u>	<u>2020</u>	<u>2040</u>
<b>REGION A</b>			
Stockdale, City of	0.244	0.372	0.436
Sunko WSC	0.340	0.470	0.556
SS WSC	0.606	0.837	0.990
Oak Hill WSC	0.293	0.405	4.479
Floresville, City of	0.932	1.670	1.961
Poth, City of	0.322	0.526	0.581
Three Oaks WSC	0.168	0.232	0.275
El Oso WSC	0.632	0.778	0.914
Falls City WSC	0.091	0.115	0.119
Karnes City, City of	0.366	0.451	0.470
Kenedy, City of	0.609	0.775	0.804
Runge, City of	0.146	0.187	0.193
	<hr/>	<hr/>	<hr/>
	4.8 MGD	6.8 MGD	7.8 MGD
<b>REGION B</b>			
Poteet, City of	0.942	1.335	1.538
Benton City WSC	-0-	0.616	0.749
McCoy WSC	0.326	0.422	0.506
Pleasanton, City of	1.389	2.211	2.659
Jourdanton, City of	0.598	1.152	1.376
Charlotte, City of	0.220	0.463	0.526
	<hr/>	<hr/>	<hr/>
	3.5 MGD	6.2 MGD	7.4 MGD
<b>REGION C</b>			
Devine, City of	0.562	0.895	0.972
Bigfoot WSC	-0-	0.026	0.027
Moore WSC	0.031	0.033	0.034
Pearsall, City of	1.430	2.134	2.505
Dilley, City of	0.590	0.833	0.924
	<hr/>	<hr/>	<hr/>
	2.6 MGD	3.9 MGD	4.5 MGD

## **7.0 EVALUATION OF ALTERNATIVES**

### **7.1 GENERAL**

Evaluation of the alternatives recommended for further study considered location, water use, water quality, proposed facilities, and cost. The water supply source and supply facilities were sized and evaluated on the basis of average daily demand. Water supply sources are generally lakes or aquifers with large storage capacity that are able to equalize peak demands. Water treatment and high service pumping, however, were sized and evaluated on the basis of peak day demand. Use of peak day demand sizing of water system infrastructure lends confidence to the design adequacy for all supply needs.

Water quality was evaluated by comparing drinking water quality records of each participating municipality to published Drinking Water Standards of the Texas Natural Resource Conservation Commission (TNRCC) and the Environmental Protection Agency (EPA) as attached in Appendix A. The primary concern of drinking water quality in the AACOG project area has been with Total Dissolved Solids (TDS) concentration and other TDS contributing elements such as chloride and sodium.

Currently, State and Federal drinking water standards allow TDS of a maximum 1000 ppm. Secondary TDS standards are proposed of a maximum 500 ppm. High Total Dissolved Solids concentrations have shown to be detrimental to poultry production and may increase risk to human health.

Location of participating municipalities in relation to each other and to adjacent "non-participating" water purveying entities resulted in the three noted project regions. Quality of water source and water supply need also influenced setting the project regions.

Cost comparisons illustrate present worth values and annualized costs. Present worth values account for all costs over the life of the project as if they all occurred at the start of the project. Annualized costs represent a yearly payment on the project as if funds were borrowed at the beginning to pay for all expenses over the life of the project.

Two alternatives are compared in this analysis. The first alternative assumes each participating municipality will remain autonomous in its water supply, treatment, and distribution system. The second alternative examines the creation of three regionalized systems within the four county AACOG project area and proposes connecting infrastructure and shared water supplies.

A third alternative should be noted which incorporates a future surface water source into the infrastructure of the second alternative. This third alternative is dependent upon either the City of San Antonio or the City of Corpus Christi constructing a surface water reservoir and/or water treatment facilities adjacent to a new or existing reservoir large enough to serve the regional system or systems. This third alternative is not compared on the basis of cost because it is apparent it will be the most costly alternative.

## **7.2 AUTONOMOUS WATER SYSTEMS**

Currently, all participating municipalities are autonomous in their water supply, treatment and distribution systems. It is possible that all participating municipalities remain autonomous in their water systems through the planning period. Previous sections have noted that groundwater is available in adequate supply for all cities in the planning area.

Water quality is a concern for those municipalities in Karnes County served by secondary aquifers, namely the Catahoula Formation and Oakville Sandstone. Karnes City has taken action to gain water supply from El Oso WSC which has wells in the Carrizo Aquifer north of Falls City. Kenedy is currently planning Reverse Osmosis treatment of well water to meet drinking water standards. Runge is planning construction of a new well with improved water quality to blend with their other wells and meet drinking water standards.

The cost of remaining autonomous is based upon upkeep of the existing system, replacement of water supply and infrastructure as required to maintain current capacity, and construction of new supply and infrastructure to meet future demands. The alternative of remaining autonomous is compared to the alternative of a regional water supply by comparing only the cost of individual water supply to the cost of infrastructure connecting the various water supplies of adjacent water purveying entities.

The cost of remaining autonomous for each participating municipality is given in Table 7.2-1:

**TABLE 7.2-1**  
**COST OF REMAINING AN AUTONOMOUS WATER PURVEYING ENTITY**  
**IN 1994 DOLLARS THROUGH DESIGN YEAR 2020**

	<u>Cost to Maintain Current Rated Capacities</u>	<u>Cost to Meet Future Needs</u>	<u>Total</u>
Falls City	358,000	-0-	358,000
Floresville	473,000	588,000	1,061,000
Karnes City	260,000	7,000	267,000
Kenedy	415,000	14,000	429,000
Pearsall	1,054,000	322,000	1,376,000
Pleasanton	938,000	329,000	1,267,000
Runge	217,000	224,000	441,000

### 7.3 REGIONAL WATER SYSTEMS

A regional water system would interconnect water supplies from adjacent water purveying entities. Advantages would include:

- \* Greater component reliability
- \* Immediate increase in water supply
- \* Allow postponement of procuring independent water supplies
- \* Show shared expenses in processing new "best quality" water supplies
- \* Provide revenue for individual entities that sell water to regional system

The AACOG project area lends itself to division into three (3) Regional Systems. Region A would

Figure 73 - 1

Region A  
Proposed Water System



Map Scale: 1" = 5.5 miles

Map Legend

- Booster Pump Station
- 18" Line
- 16" Line
- 14" Line
- 12" Line
- 10" Line
- 8" Line

- OKS - KARNES CO. UTILITY
- 10570 - El Oso WSC
  - 10573 - Fishing - Papp WSC
  - 10565 - Three Oaks WSC
  - 10566 - Sunko WSC
  - 10725 - Falls City of
  - 10726 - Falls City of
  - 10254 - Karnes City of
  - 20254 - Falls City of
  - 20255 - Kennedy City of
  - 20263 - Karnes City of

- OKS - WILSON CO. UTILITY
- 10570 - El Oso WSC
  - 10577 - Oak Hill WSC
  - 10552 - East Central WSC
  - 10553 - West Central WSC
  - 10554 - Sunko WSC
  - 10560 - Stockdale City of
  - 10562 - Polk City of
  - 10566 - Florence City of
  - 11489 - S S WSC
  - 12020 - Calico Water Supply Inc.
  - 12095 - Shady Oaks Water Co.
  - 12215 - Hickory Hill Water Co. Inc.
  - 12270 - Lake Creek Branch
  - 12270 - Lake Valley Water Co. Inc.
  - 20276 - Polk City of
  - 20279 - Florence City of
  - 20280 - Stockdale City of

Regional Data Center

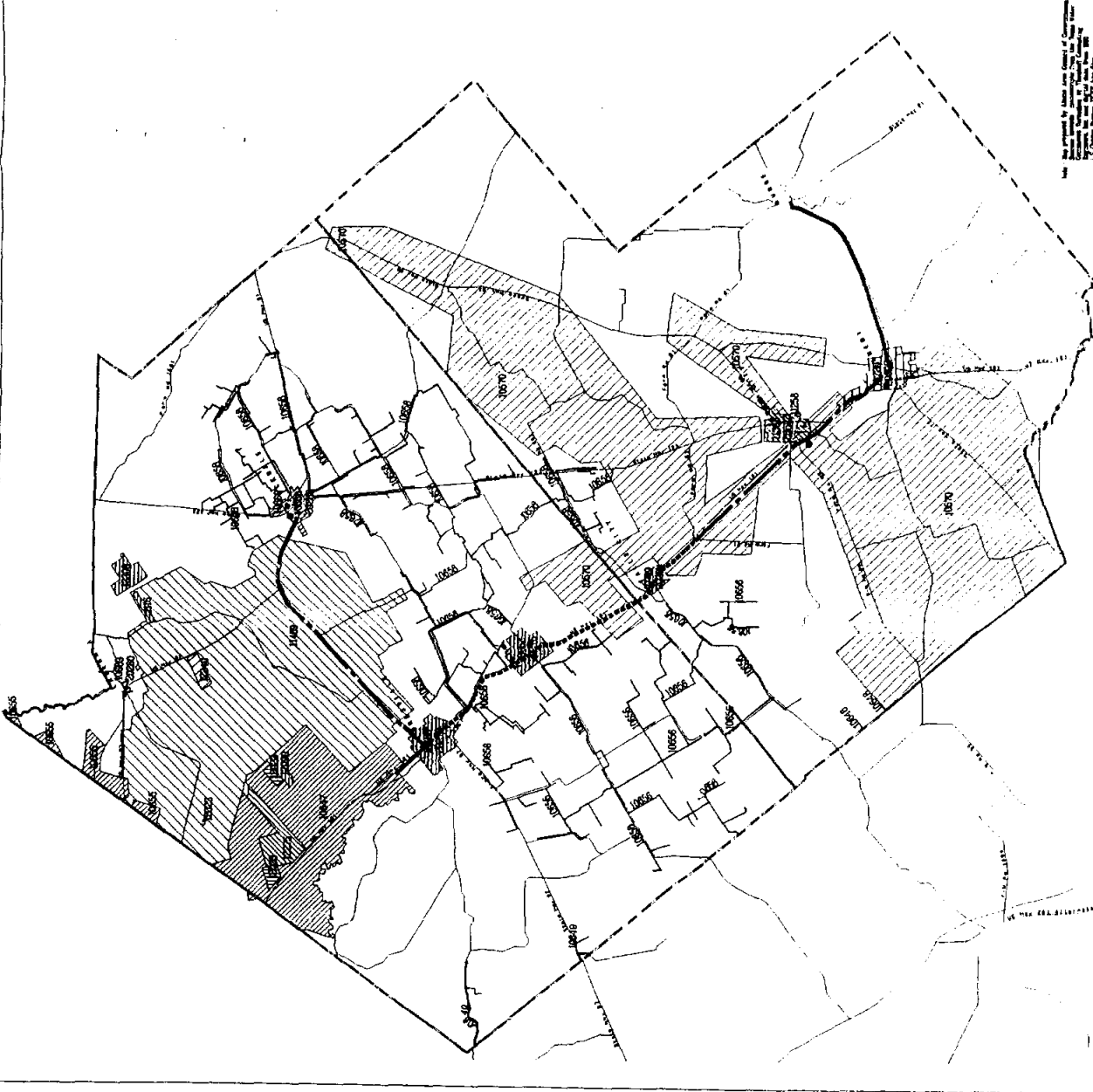

Map prepared by: [unreadable]  
 Date: [unreadable]  
 Scale: 1" = 5.5 miles  
 Project: [unreadable]

Figure 7.3 - 2

Region B  
Proposed Water System

Map Scale : 1" = 4.5 miles



Map Legend

- Booster Pump Station
- 18" Line
- 16" Line
- 14" Line
- 12" Line
- 10" Line
- 8" Line

- CDL - ATASCOSA CO. UTILITY
- 10041 - Tarrant Water Services, Inc.
  - 10042 - Tarrant Water Services, Inc.
  - 10043 - Tarrant Water Services, Inc.
  - 10044 - Tarrant Water Services, Inc.
  - 10045 - Tarrant Water Services, Inc.
  - 10046 - Tarrant Water Services, Inc.
  - 10047 - Tarrant Water Services, Inc.
  - 10048 - Tarrant Water Services, Inc.
  - 10049 - Tarrant Water Services, Inc.
  - 10050 - Tarrant Water Services, Inc.
  - 10051 - Tarrant Water Services, Inc.
  - 10052 - Tarrant Water Services, Inc.
  - 10053 - Tarrant Water Services, Inc.
  - 10054 - Tarrant Water Services, Inc.
  - 10055 - Tarrant Water Services, Inc.
  - 10056 - Tarrant Water Services, Inc.
  - 10057 - Tarrant Water Services, Inc.
  - 10058 - Tarrant Water Services, Inc.
  - 10059 - Tarrant Water Services, Inc.
  - 10060 - Tarrant Water Services, Inc.
  - 10061 - Tarrant Water Services, Inc.
  - 10062 - Tarrant Water Services, Inc.
  - 10063 - Tarrant Water Services, Inc.
  - 10064 - Tarrant Water Services, Inc.
  - 10065 - Tarrant Water Services, Inc.
  - 10066 - Tarrant Water Services, Inc.
  - 10067 - Tarrant Water Services, Inc.
  - 10068 - Tarrant Water Services, Inc.
  - 10069 - Tarrant Water Services, Inc.
  - 10070 - Tarrant Water Services, Inc.
  - 10071 - Tarrant Water Services, Inc.
  - 10072 - Tarrant Water Services, Inc.
  - 10073 - Tarrant Water Services, Inc.
  - 10074 - Tarrant Water Services, Inc.
  - 10075 - Tarrant Water Services, Inc.
  - 10076 - Tarrant Water Services, Inc.
  - 10077 - Tarrant Water Services, Inc.
  - 10078 - Tarrant Water Services, Inc.
  - 10079 - Tarrant Water Services, Inc.
  - 10080 - Tarrant Water Services, Inc.
  - 10081 - Tarrant Water Services, Inc.
  - 10082 - Tarrant Water Services, Inc.
  - 10083 - Tarrant Water Services, Inc.
  - 10084 - Tarrant Water Services, Inc.
  - 10085 - Tarrant Water Services, Inc.
  - 10086 - Tarrant Water Services, Inc.
  - 10087 - Tarrant Water Services, Inc.
  - 10088 - Tarrant Water Services, Inc.
  - 10089 - Tarrant Water Services, Inc.
  - 10090 - Tarrant Water Services, Inc.
  - 10091 - Tarrant Water Services, Inc.
  - 10092 - Tarrant Water Services, Inc.
  - 10093 - Tarrant Water Services, Inc.
  - 10094 - Tarrant Water Services, Inc.
  - 10095 - Tarrant Water Services, Inc.
  - 10096 - Tarrant Water Services, Inc.
  - 10097 - Tarrant Water Services, Inc.
  - 10098 - Tarrant Water Services, Inc.
  - 10099 - Tarrant Water Services, Inc.
  - 10100 - Tarrant Water Services, Inc.

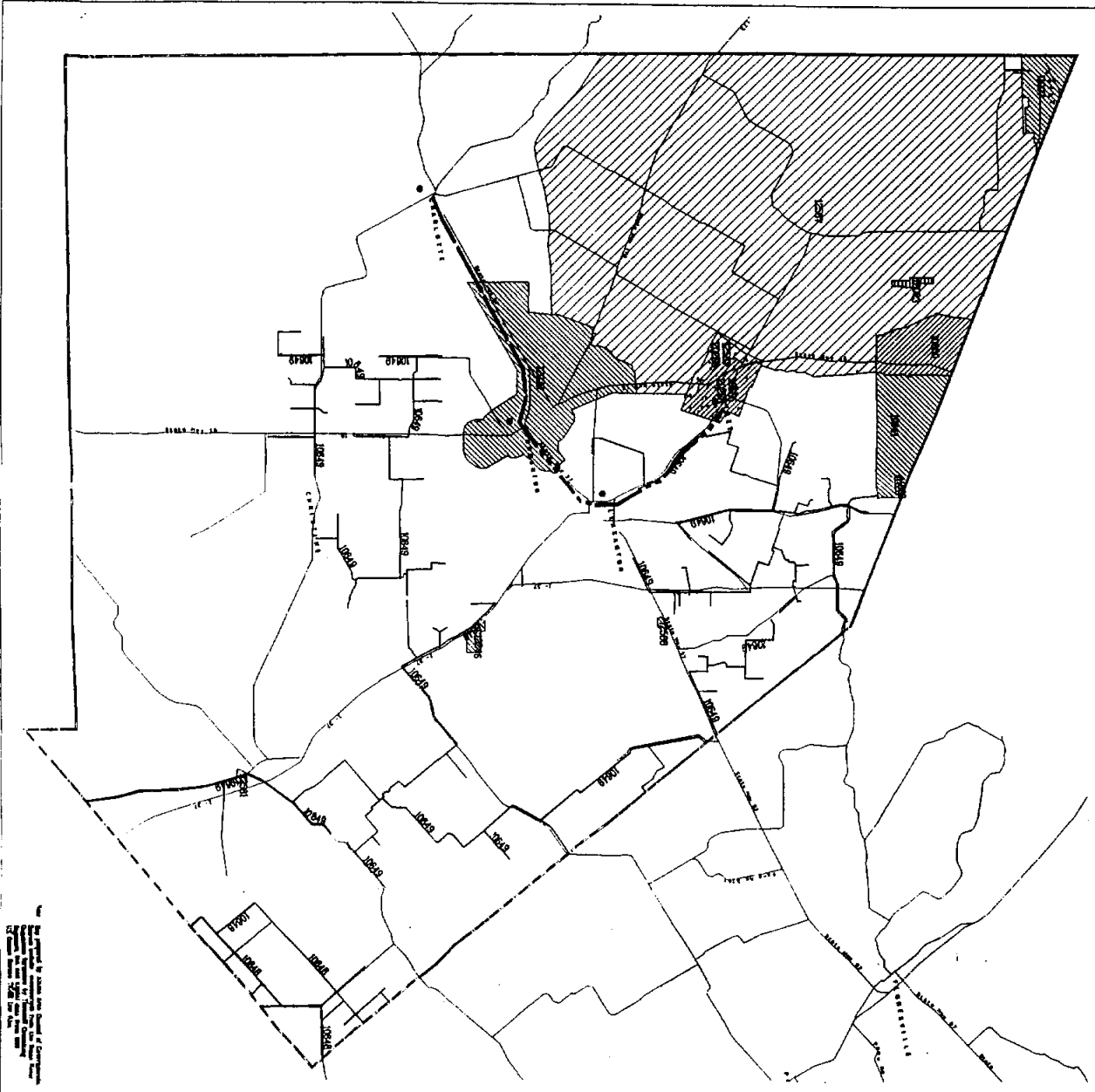

Regional Data Center

Figure 7.3 - 3

Region C  
Proposed Water System

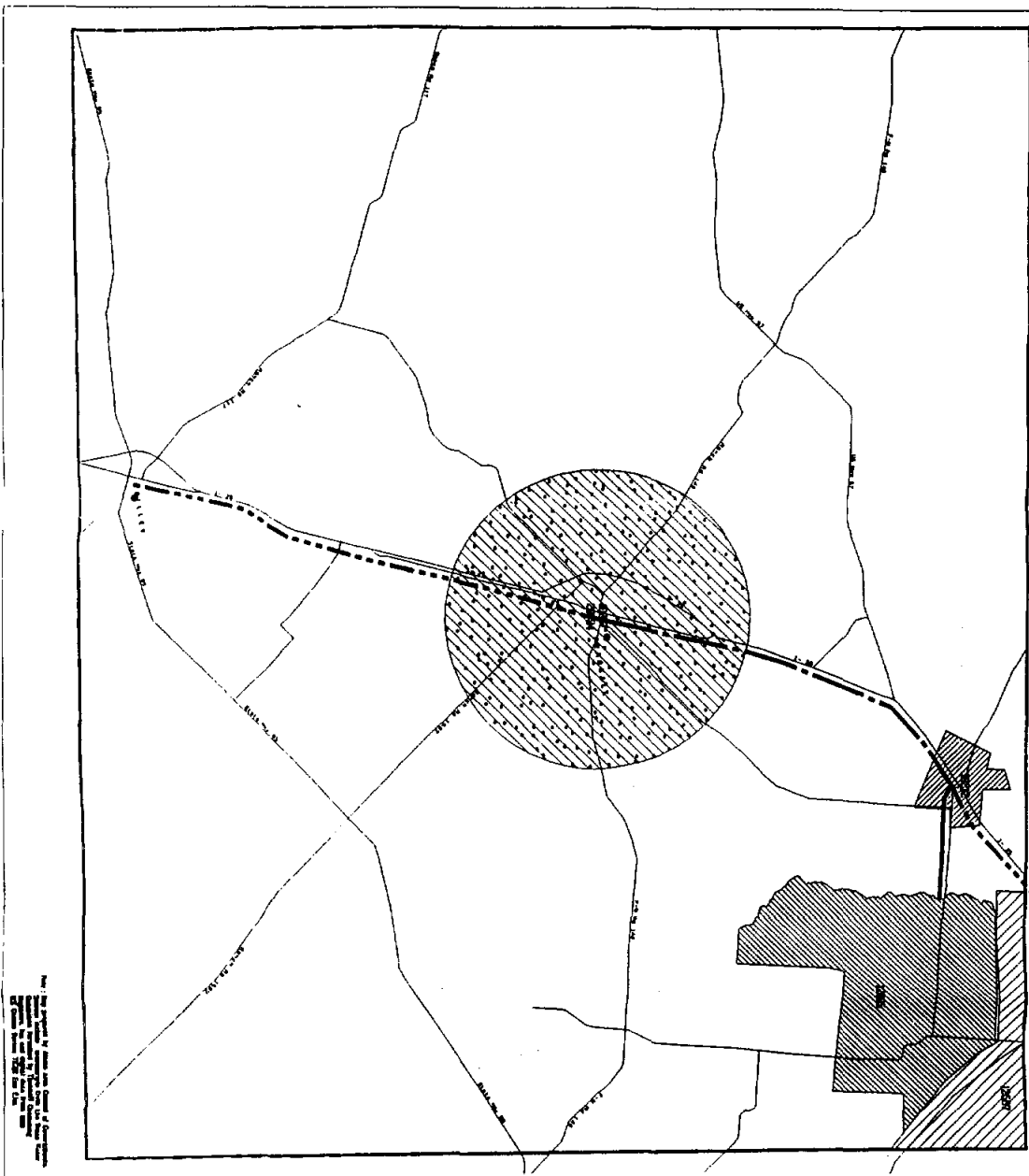

Map Scale : 1" = 30 miles

- Map Legend
- Booster Pump Station
  - 36" Line
  - 30" Line
  - 24" Line
  - 18" Line
  - 12" Line
  - 6" Line

- OCN - FRBO CO UTILITY
- 10212 - Moore Water Supply Corp
- 10217 - Peavall City of
- 11003 - Tuley City of
- 11004 - Tuley City of
- 20004 - Peavall City of





incorporate entities in Wilson and Karnes County. Region B would incorporate entities in Atascosa County, and Region C would incorporate entities in Frio and possibly Medina County. These areas are illustrated on Figures 7.3-1, 7.3-2, and 7.3-3 respectively. Proposed infrastructure is also shown on these figures. Total Capital Cost projections are itemized in Appendix B for each alternative and are summarized as follows:

Region A	\$6,300,000
Region B	\$2,400,000
Region C	\$4,200,000

As previously noted, these cost projections include all water purveying entities adjacent to or of reasonable proximity to a participating municipality. It is assumed in this preliminary design that existing ground storage tanks can be used at each booster pump station location.

#### 7.4 SUMMARY OF ANALYSIS

Several general conclusions can be drawn from these analyses:

- \* Adequate groundwater quantity is available to each participating municipality through design year 2040
- \* Three participating municipalities (Karnes City, Kenedy, and Runge) own groundwater wells which do not meet drinking water quality standards. This groundwater can meet drinking water quality standards through treatment or mixing with "higher quality" water
- \* Existing groundwater sources meeting drinking water quality standards appear adequate to serve all noted water purveying entities in each Region including those with substandard water quality sources
- \* Each participating municipality could provide for autonomous water supply, treatment, and distribution

- \* Regional water supply utilizing groundwater resources from each participating entity could provide service through design year 2040
- \* Any surface water alternative would require the piping and pumping infrastructure of the groundwater alternative and would be more expensive through construction of a surface water impoundment and a water treatment plant.

A cost comparative analysis between the two alternatives, at this time, cannot be comparative because of inclusion of the non-participating entities in the regional plan. A cursory opinion indicates that the regional plan may prove cost-effective. However, until a detailed examination of all components of the non participating entities can be accomplished, a detailed cost-effective analysis can not be performed.

## **8.0 IMPACT OF WATER CONSERVATION**

### **8.1 GENERAL**

Another means of managing any supply and demand problem is conservation. In this study, both high and low water demand figures for each of the municipalities were used assuming water conservation and no water conservation.

Water conservation practices can reduce the amount of water usage by as much as 10 to 15 percent depending on the plan. Projections included in this report show a significant reduction. Projected gallons per day per capita are projected to be reduced in 2040 by as much as 16 to 18 percent in a majority of the participating municipalities.

In the smallest participating municipality, Falls City, and despite a population increase of approximately 9 percent, water usage with conservation practices can be reduced by 15.7 percent in the year 2040.

Of the remaining municipalities Karnes City showed the most potential for reducing water usage with conservation practices. Reductions in the year 2000 averaged 4.4 to 5.2 percent depending on whether the high or low water usage projections were used. In 2020 the amount of reduction was 14.8 for both high and low projections. And finally in 2040, Karnes City is projected to reduce its water usage of gallons per day per capita by 19.3 percent with its low projection and 18.5 percent in its high projection.

Table 8.1-1 includes all of the municipalities with the percentage of reductions between water usage with conservation and water usage without conservation in each given year for both high and low water usage projections.

**TABLE 8.1-1**

**PERCENTAGE OF REDUCTION IN WATER USAGE  
WITH CONSERVATION PRACTICES  
LOW PROJECTIONS**

	FALLS CITY	FLORESVILLE	KARNES CITY	KENEDY	PEARSALL	PLEASANTON	RUNGE
2000	3.3%	5.0%	4.4%	3.9%	3.7%	5.0%	4.9%
2010	8.0%	9.9%	9.6%	8.3%	8.3%	10.1%	9.7%
2020	11.9%	13.8%	14.8%	12.8%	12.4%	14.0%	13.9%
2030	13.8%	14.9%	17.0%	14.4%	13.3%	15.6%	16.0%
2040	15.7%	16.0%	19.3%	16.11%	14.7%	14.7%	18.0%

**TABLE 8.1-2**

**PERCENTAGE OF REDUCTION IN WATER USAGE  
WITH CONSERVATION PRACTICES  
HIGH PROJECTIONS**

	FALLS CITY	FLORESVILLE	KARNES CITY	KENEDY	PEARSALL	PLEASANTON	RUNGE
2000	5.2%	5.0%	5.2%	4.4%	4.1%	5.0%	4.9%
2010	9.5%	9.9%	9.6%	8.8%	8.7%	10.0%	9.7%
2020	12.9%	13.8%	14.8%	12.8%	12.4%	14.5%	13.9%
2030	14.3%	14.9%	17.0%	14.4%	13.3%	15.6%	16.0%
2040	16.2%	16.0%	18.5%	16.1%	14.7%	16.8%	18.1%

With respect to the suggested alternatives, the percentage of reduction in water usage will reduce the total project cost about the same percentage. This reduction in water use through conservation will lower the cost of construction of new water facilities due to a possible reduction in pipe size diameter and capacity of booster pump stations. A reduction in water use could also extend the design life of the facilities.

Either legislation or an increased cost of water can encourage water conservation. It is possible that future legislation could require the implementation of a water conservation plan. Increasing water cost will also encourage water conservation. Water conservation is a good water management tool.

A Water Conservation and Emergency Water Demand Management Plan is attached in Appendix D of this report. This plan sets goals for water conservation and specifies ways to implement and encourage water conservation.

## **9.0 ENVIRONMENTAL, SOCIAL AND ECONOMIC ANALYSIS OF STUDY AREA**

### **9.1 GENERAL**

Prior to the construction of any facility that will provide an alternative water source, a series of impact assessments must be made. It is imperative that factors such as social and economic, historical and archaeological, and ecological be taken under advisement and studied. For every action there is a reaction or impact, and it is necessary to be aware of exactly what the result of an action will be. The Regional Water Supply System alternative can accommodate construction within the state highway right-of-way and have negligible impact on any of the above concerns. However, this section will explore the factors to be considered on a countywide basis that can be applied as needed to each individual alternative.

### **9.2. SOCIAL AND ECONOMIC ASSESSMENT**

Much of the economic activity in Atascosa, Frio, Karnes and Wilson counties deals with farming and ranching. Mining activities, such as surface mining operation, also produce some jobs in Karnes County, but because of continuous layoffs by mining companies, are not considered a significant industry. Public service oriented employment, such as hospitals, cities, counties and school districts, is increasing in many of the small communities located in the four counties.

According to the U.S. Census Bureau - County Business Pattern, the major employment sectors in the four county region are primarily agriculture and retail trade. In addition, construction is also designated as an important employment sector in Atascosa County.

Employment in Atascosa, Frio and Wilson Counties increased from 1980 to 1990. The only county showing a decrease in the number of employed persons was Karnes County with a 21.2% decline

**TABLE 9.2-1**  
**Employment in AACOG Project Area**

	<u>1980</u> <u>Employment</u>	<u>1990</u> <u>Employment</u>	<u>% Growth</u>
Atascosa	9,657	10,529	9.0
Frio	4,790	5,985	25.0
Karnes	5,262	4,148	-21.1
Wilson	6,761	9,119	34.9

Source: Texas Employment Commission

The average per capita income for the four county area doubled from 1980, where it was an average of \$4,916, to \$10,793 in 1990. Frio County has the lowest per capita income at \$8,274. Per Capita Income for Counties located in the AACOG Region in 1980 & 1990 are given in Table 9.2-2.

**TABLE 9.2-2**  
**Per Capita Income in AACOG Project Area**

	<u>1980</u>	<u>1990</u>
Atascosa Co.	\$4,949	\$10,782
Frio Co.	4,137	8,274
Karnes Co.	5,343	11,796
Wilson Co.	5,243	12,317

\* Bureau of Economic Analysis, U.S. Department of Commerce

### **9.3 HISTORIC AND ARCHAEOLOGICAL ASSESSMENT**

According to the list of National Register Sites, Atascosa and Wilson Counties do not contain any registered sites. However, Copono Ranch in Atascosa County has been determined as eligible for the National Register. Atascosa does not contain any state archaeological landmarks; however, Wilson County does have three designated state landmarks: Rancho de las Cabras State Historical Site, Wilson County Courthouse, and Wilson County Jail.

The old Frio County Jail is included in the National Register and also is listed as a state archaeological landmark. Karnes County contains two national register sites: Panna Maria Historic District in Panna Maria, Texas, and the John Ruckman House in Helena, Texas. Also, certain publicly owned portions in Karnes County are designated as state archaeological landmarks.

### **9.4 ECOLOGICAL ASSESSMENT**

In the siting, design and operation of alternative water supply sources, natural areas and species of concern should be carefully considered, not only for their inherent ecological value but also because of growing public sensitivity over dwindling natural resources.

Much of the four county region contains some types of tributary such as rivers, streams and creeks which not only provide springflow to supply humans and wildlife with needed water, but may also provide actual habitat for diversity of native plant and animal species. Some of these unique species are listed by the Texas Parks and Wildlife Department as threatened or endangered.

#### **9.4.1. River Basins**

The four county region is drained by three major drainage basins: (1) the Guadalupe River Basin, (2) the San Antonio River Basin, and (3) the Nueces River Basin. For purposes of this study only those counties involved in this study will be used in the description of the basins.

The Guadalupe River Basin drains small sections of Wilson and Karnes Counties. The basin consists of the Guadalupe River and two of its major tributaries, the Blanco River and the San Marcos River.



The San Antonio River Basin travels through major portions of Karnes County and small sections of Atascosa County. Rivers comprising this drainage basin include the San Antonio River and three of its major tributaries, the Medina River, Cibolo Creek and Leon Creek.

The southernmost drainage basin in the four county region is the Nueces River Basin. This basin crosses major portions of Frio and Atascosa counties and small sections of Wilson and Karnes Counties. Major tributaries draining into the Nueces include Sabinal River, Frio River, Hondo Creek, Atascosa River, San Miguel Creek and Seco Creek. Choke Canyon Reservoir, along the Frio River is located just south of the AACOG Project Area in Live Oak County.

#### **9.4.2 Wetlands**

Wetlands are generally present near rivers, streams and creeks and should be an important factor to consider when evaluating alternative water supply sources. Natural wetlands may occur in low-lying areas, particularly where the water table is close to the surface or where artesian flow is present.

Wetlands are protected by the United States Fish and Wildlife Service because of their ecological value, particularly as nesting areas for migratory birds and other wildlife, and because of the importance of wetlands in the natural recycling of groundwater. Wetlands effectively remove pollutants from surface water.

Wetlands are subject to regulation by the U.S. Army Corp of Engineers under the Clean Water Act of 1977. In most cases, the Corp requires that any wetlands filled by project activities or requirements must be mitigated or replaced. Wetland mitigation can be a very expensive endeavor and should be avoided to decrease costs. Currently, no wetland areas have been identified in areas of the proposed improvements.

#### **9.4.3 Endangered or Threatened Species**

The Federal Endangered Species Act protects species classified as threatened or endangered, and protection of the species extends to their habitats as well. According to inquiries made to the U.S. Fish and Wildlife Service, there are no federally designated endangered or threatened species in the

Atascosa, Frio, Karnes and Wilson Counties with permanent habitat. However, the Whooping Crane was designated as an endangered migratory bird. The Cranes's migration pattern includes the area over the AACOG Project Area.

The Texas Parks and Wildlife Department maintains its own system of classifying species of concern which, in most cases, overlaps with the federal system, but includes some additional species. The Texas Parks and Wildlife Department ran its inquiries based on a map of the four counties and participating municipalities. The following Table 9.4-1 outlines the information provided.

**TABLE 9.4-1  
LIST OF ENDANGERED SPECIES FOUND IN THE AACOG PROJECT AREA**

<u>COMMON NAME</u>	<u>SCIENTIFIC NAME</u>	<u>COUNTIES OF OCCURRENCE</u>
<b><u>BIRDS</u></b>		
Bald Eagle	<i>Haliaeetus leucocephalus</i>	Atascosa, Frio and Karnes
Interior Least Tern	<i>Sterna antillarum athalassos</i>	Atascosa, Frio and Karnes
Whooping Crane	<i>Grus americana</i>	Karnes and Wilson
Golden-cheeked Warbler	<i>Dendroica chrysoparia</i>	Atascosa and Wilson
Brown Pelican	<i>Pelecanus occidentalis</i>	Atascosa, Frio, Karnes and Wilson
Arctic Peregrine Falcon	<i>Falco peregrinum tundrius</i>	Atascosa, Frio, Karnes and Wilson
American Peregrine Falcon	<i>Falco peregrinum anatum</i>	Atascosa, Karnes and Wilson
Zoned-Tail Hawk	<i>Buteo albonotatus</i>	Atascosa and Frio
White-Faced Ibis	<i>Plegadis chihi</i>	Atascosa, Frio, Karnes and Wilson
American Swallow-Tailed Kite	<i>Elanoides forficatus</i>	Atascosa, Karnes and Wilson
Wood Stork	<i>Mycteria americana</i>	Frio, Karnes and Wilson
<b><u>MAMMALS</u></b>		
Ocelot	<i>Felis pardalis</i>	Atascosa and Frio
Black Bear	<i>Ursus amicanus</i>	Frio

**TABLE 9.4-1  
(continued)**

<u>COMMON NAME</u>	<u>SCIENTIFIC NAME</u>	<u>COUNTIES OF OCCURRENCE</u>
<b><u>REPTILES</u></b>		
Texas Tortoise	<i>Gopherus beriandieri</i>	Atascosa, Frio, Karnes and Wilson
Texas Horned Lizard	<i>Phrynosoma cornutum</i>	Atascosa, Frio, Karnes and Wilson
Texas Indigo Snake	<i>Phrynosoma cornutum</i>	Atascosa, Frio, Karnes and Wilson
Sheep Frog	<i>Hypopachus variolosus</i>	Atascosa and Karnes
Timber Rattlesnake	<i>Crotalus horridus</i>	Karnes and Wilson
Reticulate Collared Lizard	<i>Crotaphytus reticulatus</i>	Frio
Spot Tailed Earless Lizard	<i>Holbrookia lacerata</i>	Atascosa and Karnes
Keeled Earless Lizard	<i>Holbrookia propinqua</i>	Atascosa and Wilson

## 9.5 REGIONAL AQUIFER WELLHEAD PROTECTION

Any water quantity initiatives should obviously be coupled with water quality protection measures. Adequate steps to protect aquifer water quality by preventing any man made contamination and utilizing proper conservation measures to lessen the impact of natural contaminants should be implemented. It is recommended that this AACOG project area aggressively pursue a regional aquifer and wellhead protection program.

One of the most effective methods of protecting ground water is through the Regional Aquifer and Wellhead Protection Program administered by the Texas Natural Resources Conservation Commission (TNRCC). The program is voluntary. TNRCC provides the local communities with any needed technical assistance or public education and can implement the program without any cost to the local governments.

Presently, TNRCC is in the process of implementing regional aquifer and wellhead protection measures in the Carrizo-Wilcox of south-central Texas, through the Clean Water Act. Counties in this area include Atascosa, southern Bexar County, Frio, Guadalupe, Karnes, Medina and Wilson Counties. The goal of the program is to offer wellhead protection fundamentals to the identified region and unify local ground water protection efforts.

The basic concept of wellhead protection is to minimize land use restrictions while maximizing ground water protection, while at the same time emphasizing the empowerment of local governments to more effectively deal with state and federal regulations. The role of the Regional Aquifer and Wellhead Protection Program is to:

- \* Provide information that local authorities and the public can use to implement best management practices for ground-water protection in planning decisions.
- \* Review contingency plans for the provision of alternate water supplies;
- \* Provide guidance (i.e. local seminars, educational, material, etc.) to the local government in its inventory of all potential contaminants within the wellhead

protection areas.

The entity must then enact appropriate best management practices to prohibit or control the inventoried sources which are a threat to ground water. The entity will also be responsible for conducting a re-inventory of potential sources at two to five year intervals which is provided to the state for updating purposes.

The data gathered and generated by this program will be stored in reports and digitized form at a central clearinghouse for use in further protection. In the Carrizo-Wilcox area the Evergreen Underground Water Conservation District (EUWCD) is sponsoring a regional aquifer and wellhead protection program and is being used as a clearinghouse for their region. TNRCC has one of the top nationally recognized programs for wellhead protection and stands ready to help. Contact AACOG, EUWCD, or the Commission at (512) 475-4594 or (512) 463-0292 for more information.

## **10.0 IMPLEMENTATION PLAN**

### **10.1 DESCRIPTION OF PROPOSED PLAN**

The proposed plan would divide the four county AACOG project area into three (3) Regional Water Supply systems.

Region A would include the following entities in Wilson and Karnes Counties:

- Stockdale, City of
- Sunko WSC
- SS WSC
- Oak Hill WSC
- Floresville, City of
- Poth, City of
- Three Oaks WSC
- El Oso WSC
- Falls City, City of
- Karnes City, City of
- Kenedy, City of
- Runge, City of

Region B would include the following entities in Atascosa County:

- Poteet, City of
- Benton City WSC
- McCoy WSC
- Pleasanton, City of
- Jourdanton, City of
- Charlotte, City of

Region C would include the following entities in Frio County:

- Devine, City of
- Bigfoot WSC
- Moore WSC
- Pearsall, City of
- Dilley, City of

All participating municipalities should continue to utilize, repair, replace, and expand their existing water systems until the regional system is in place. The primary source of water supply would be groundwater from the Carrizo Aquifer. Region B would provide a large portion of the water supply from The Queen City Aquifer; however, the Carrizo Aquifer may prove more economical when new large capacity wells are needed.

Surface water should be evaluated if and when San Antonio constructs any surface water impoundments and constructs water treatment facilities or when Corpus Christi constructs surface water treatment facilities at Choke Canyon Reservoir.

Entities that require higher quality water or greater quantity of water would purchase water from the regional system. Entities that have an excess of water meeting drinking water quality would sell water to the regional system.

## **10.2 FINANCIAL CONSIDERATIONS**

Final cost of the project will be dependent on the schedule of the project. Construction costs will be most of the expense. Costs shown in this report are based on 1994 costs. These costs will have to be updated to the year of construction when that year can be better estimated. Design and construction cannot start until all legal agreements between involved parties are executed.

Since there is no ongoing revenue stream, interest during construction will have to be capitalized as a part of one of the bond issues. At least two bond issues are expected. One issue is needed to finance the cost of planning and design and one to finance the cost of construction. Since the design phase is expected to take about one year, staggering the bond issue for construction can save one year of interest on construction cost.

## **10.3 COST OF WATER**

Two categories of cost must be analyzed when determining the cost of water. The first category includes only the cost of the Regional System infrastructure. The second category is the cost for all entities to maintain their current groundwater production facilities. Additional wells to meet future



water demands could be added either by the individual entity or by the Regional System.

The Regional System infrastructure would be a fixed cost shared proportionally based upon number of customers potentially served. For example, in Region A, the City of Runge could be served up to 100% of its customers while the City of Floresville may be served by the Regional System up to about 75% of its customers.

The O & M cost for water would vary between entities. The regional system should obtain water at no more cost than the entity is selling water to its own customers. The regional system would then sell water at the weighted average rate that it is procuring water plus its own O & M costs. The fixed costs of the regional system infrastructure would be incorporated into the individual water rate of each entity as it sells water to its own customers.

Administration for the three Regions could be performed at one location. The participating entities each could supply an in-house maintenance crew to perform needed repairs and maintenance for the Regional System. The Regional System administration would schedule their crews for scheduled maintenance and call the nearest available crew to perform spot repairs. Costs for repair and maintenance crews would be billed back to the Regional System and budgeted to the participating entities within the applicable participating region.

## **10.4 ORGANIZATIONAL OPTIONS**

### **10.4.1 General**

Several organizational options are available for implementation of this plan. The ones best suited for this plan are regional water supply districts, regional water supply corporations, the San Antonio River Authority for Region A, the Nueces River Authority for Regions B and C, or a combination of regional water supply corporation or district and the appropriate River Authority.

### **10.4.2 Regional Water Supply District**

A regional water supply district can be formed to construct, own, and operate the regional facilities.

This district would be a political subdivision of the state and created by the State. It can be created by the Texas Natural Resource Conservation Commission as a Municipal Utility District with the defined powers authorized by law by this process. It can also be created through legislation and be made with the powers that the sponsors select.

Some of the advantages of implementation with this method are:

- \* Can be very flexible in its creation if created through legislation
- \* Can have the power of eminent domain in order to acquire necessary land

Some of the disadvantages are:

- \* May be viewed negatively as another layer of government especially if given taxing authority.
- \* Can be time consuming to create especially if by legislation and the legislators are not due to be in session for several months.

#### **10.4.3 Regional Water Supply Corporation**

The main differences between this corporation and the district previously discussed is that this corporation is not a governmental body. It is a private non-profit corporation. Its advantages are:

- \* Its powers are very flexible and can be created with the powers the sponsors want.
- \* It can be formed relatively quickly in comparison with the District.
- \* Will not be viewed as another layer of government.

Some of the disadvantages are:

- \* Has no right of eminent domain to condemn property if essential to the project

- \* Cannot be given taxing authority if desired by the sponsors

- \* Cannot issue tax free bonds

#### **10.4.4 River Authorities**

Both the San Antonio River Authority and the Nueces River Authority are existing state agencies created by the State of Texas to protect and develop water resources in their assigned river basin. A River Authority is governed by a board of directors normally appointed by the Governor with membership from the area of its jurisdiction; however, The San Antonio River Authority utilizes an elected board of directors. A River Authority may own, construct and operate regional water supply facilities. Revenues are generally raised by sale of water on a take or pay basis. Contractual agreements are needed between the River Authority and the individual entities contracting for the water. These contracts define the rights and powers of each party.

Some of the advantages of this option are:

- \* The River Authorities already exist and were created to provide these types of services if requested by the sponsors. There will be no legal cost or time delays to form a district or corporation
- \* The River Authority has expertise in planning, constructing, and managing water related facilities
- \* The River Authority may finance the project

The main disadvantage to the use of a River Authority is that it may be perceived that the sponsors may have less direct control over the implementation and cost of the project as well as the operation of the facilities and the water rates charged. This perception would result because there are no River Authority board members who are elected or appointed by the sponsoring entities. However, other regional projects have created a management committee to represent the participants.

#### **10.4.5 Combined District or Corporation and River Authority**

Another option is to create a District or Corporation to own the facility. The district or corporation could then contract with River Authority for all of the following services: finance, construct, manage, and operate the regional facilities. This option may overcome the perceived problem of lack of direct control, but it also creates an additional agency in the process.

#### **10.4.6 Conclusion**

The selection of an organization to implement the project is an important decision which the sponsoring entities will have to make. It is recommended that if they elect to proceed with this project, that they obtain competent, impartial legal counsel to advise them.

### **10.5 SCHEDULING OF PROJECT**

The project from start of Regional Organization to the completion of construction will require approximately 36 months. The following Table summarizes the estimated schedule:

**TABLE 10.5-1  
REGIONAL WATER SYSTEM  
PROJECT SCHEDULE**

<u>PROJECT MILESTONE</u>	<u>MONTH</u>
Regional Organization	0-6
Procure Financing for Engr. Service Cost	6-8
Procure Engineering Services	6-8
Preliminary Engineering Report	8-12
Final Design Phase	12-21
Procure Financing for Construction Cost	21-23
Bid Phase	21-23
Construction Phase	23-36

## REFERENCES

The following is a list of references used in the development of this report:

1. Rules and Regulations for Public Water Systems - Texas Department of Health - Adopted 1988.
2. Drinking Water Standards Governing Drinking Water Quality and Reporting Requirements for Public Water Supply Systems, Texas Department of Health, Division Water Hygiene, Effective September 5, 1989.
3. Key Rate Schedule for Grading City and Towns of Texas, State Board of Insurance, October 1, 1982.
4. The Safe Drinking Water Act, 1986.
5. Texas Water Commission Bulletin No. 6518.
6. Texas Water Development Board, Report 210, Volume 1.1.
7. Water for Texas, Today and Tomorrow - 1990 -, Texas Water Development Board, December, 1990.
8. Water for Texas, Today and Tomorrow - 1992 -, Texas Water Development Board, December 1992.
9. Report prepared for Thonhoff Consulting Engineers, Inc., entitled "Ground Water Resources Evaluations for the AACOG Regional Water Plan for Municipalities in Atascosa, Frio, Karnes, and Wilson Counties, R.W. Harden & Associates, Inc., December 1993.

**APPENDIX A**

**WATER QUALITY STANDARDS**

PRIMARY DRINKING WATER STANDARDS  
OF THE  
TEXAS DEPARTMENT OF HEALTH

CONSTITUENT	LEVEL MILLIGRAMS PER LITER
INORGANICS	
ARSENIC .....	0.05
BARIIUM.....	1.00
CADMIUM.....	0.010
CHROMIUM.....	0.05
LEAD.....	0.05
MERCURY.....	0.002
NITRATE (AS N).....	10
SELENIUM.....	0.01
SILVER.....	0.05
FLUORIDE.....	4.0
ORGANICS	
CHLORINATED HYDROCARBONS	
ENDRIN.....	0.0002
LINDANE.....	0.004
METHOXYCHLOR.....	0.1
TOXAPHENE.....	0.005
CHLOROPHENOXY	
2,4-D.....	0.1
2,4,5-TP SILVEX.....	0.01
TURBIDITY	
TURBIDITY.....	TURBIDITY UNITS 1
BIOLOGICAL	
COLIFORM BACTERIA.....	# PER 100 ML 1 AS ARITH. MEAN OF ALL SAMPLES PER MO. OR 4 IN MORE THAN ONE SAMPLE WHEN $\leq 20$ ARE EXAMINED IN ONE MO. OR 4 IN MORE THAN 5% WHEN $\geq 20$ ARE EXAMINED IN ONE MONTH
RADIOLOGICAL	
RADIUM-226, RADIUM-228 AND GROSS ALPHA PARTICLE	
COMBINED RADIUM-226 AND RADIUM-228....	5 pCi/L
GROSS ALPHA PARTICLE ACTIVITY.....	15 pCi/L
RADIONUCLIDES	
BETA PARTICLE & PHOTON RADIOACTIVITY..	4 MILLIREM/YR. DOSAGE
TRITIUM.....	20000 pCi/L
STRONTIUM-90.....	8 pCi/L

SECONDARY DRINKING WATER STANDARDS  
OF THE  
TEXAS DEPARTMENT OF HEALTH

CONSTITUENT	LEVEL
CHLORIDE.....	300 MG/L
COLOR.....	15 COLOR UNITS
COPPER.....	1.0 MG/L
CORROSIVITY.....	NON-CORROSIVE
FLUORIDE.....	2.0 MG/L
FOAMING AGENTS.....	0.5 MG/L
HYDROGEN SULFIDE.....	0.05 MG/L
IRON.....	0.3 MG/L
MANGANESE.....	0.05 MG/L
ODOR.....	3 THRESHOLD ODOR NO.
pH.....	≥ 7.0
SULFATE.....	300 MG/L
TOTAL DISSOLVED SOLIDS.....	1000 MG/L
ZINC.....	5.0 MG/L
TOTAL TRIHALOMETHANES.....	0.1 MG/L



NATIONAL DRINKING WATER STANDARDS  
FEBRUARY 1, 1991

PRIMARY STANDARDS

CONTAMINANTS	MCLs mg/l
<b>INORGANICS</b>	
Arsenic	0.05
Asbestos	7 MFL
Barium	1
Cadmium	0.005
Chromium	0.1
Fluoride	4.0
Lead	0.05
Mercury	0.002
Nitrate	10
Nitrite	1
Nitrate plus Nitrite	10
Selenium	0.05
<b>MICROBIOLOGICAL</b>	
Total Coliform MCL:	
Compliance Criteria	a) Where at least 40 samples are collected per month, if no more than 5.0 percent are total coliform-positive. b) Where less than 40 samples are collected per month, if no more than one sample is total coliform-positive.
Violation Criteria	a) Any fecal coliform-positive or E. coli-positive repeat sample, or any total coliform-positive repeat sample following a fecal coliform-positive or E. coli-positive routine sample, constitutes a violation.
<b>TURBIDITY</b>	
Turbidity MCL	1 Turbidity Unit
	Applicable to unfiltered systems until 12/20/91, unless state determines in writing that filtration is required, in which case it is applicable to 6/29/93 or until filtration is installed, whichever is later. Applicable to filtered systems until 6/29/93.
Surface Water Treatment Rule	This rule requires filtration as a treatment technique for systems using a surface water source or a ground water source directly influenced by a surface water source. The rule is effective on the dates listed under Turbidity MCL for unfiltered and filtered systems, respectively, and requires: 99.9 percent (3 log) removal and/or inactivation of Giardia lamblia, and 99.99 percent (4 log) removal and/or inactivation of viruses. Conventional treatment meeting performance criteria achieves 2.5 log removal of Giardia and 2 log removal of viruses prior to disinfection.
<b>ORGANICS</b>	
Benzene	0.005
Carbon tetrachloride	0.005
Dichlorobenzene ortho-	0.6
Dichlorobenzene para-	0.075
Dichloroethane 1,2-	0.005
Dichloroethylene 1,1-	0.007
Dichloroethylene cis-1,2-	0.07
Dichloroethylene trans-1,2-	0.1

Dichloropropane 1,2-	0.005
Ethylbenzene	0.7
Monochlorobenzene	0.1
Styrene	0.1
Tetrachloroethylene	0.005
Toluene	1
Total Trihalomethane	0.10
Trichloroethane 1,1,1-	0.20
Trichloroethylene	0.005
Vinyl chloride	0.002
Xylenes (Total)	10

PESTICIDES & PCBs

2,4,5-TP	0.05
2,4-D	0.07
Alachlor	0.002
Atrazine	0.003
Carbofuran	0.04
Chlordane	0.002
DSCP	0.0002
EDB	0.00005
Endrin	0.0002
Heptachlor	0.0004
Heptachlor epoxide	0.0002
Lindane	0.0002
Methoxychlor	0.04
PCBs	0.0005
Toxaphene	0.003

RADIOCHEMICAL

Combined Ra-226 and Ra-228	5	picocuries/liter
Gross Alpha Particle Activity (including Ra-226, excluding radon & uranium)	15	picocuries/liter
Beta Particle & Photon Radioactivity		Average annual concentration shall not produce an annual dose equivalent to the total body or any internal organ greater than 4 millirem per year.
Tritium		20,000 picocuries/liter
Strontium-90 (bone marrow)		8 picocuries/liter

TREATMENT TECHNIQUE

Acrylamide	TT - 0.05% dosed at 1 mg/l
Epichlorohydrin	TT - 0.01% dosed at 20 mg/l

SECONDARY STANDARDS

Aluminum	0.05 to 0.2
Chloride	250
Color	15 color units
Copper	1.0
Corrosivity	noncorrosive
Fluoride	2.0
Foaming Agents	0.5
Iron	0.3
Manganese	0.05
Odor	3 threshold odor number
pH	6.5 - 8.5
Silver	0.1
Sulfate	250
Total Dissolved Solids (TDS)	500
Zinc	5

**APPENDIX B**

**WATER QUALITY REPORTS  
OF PARTICIPATING MUNICIPALITIES**

RECEIVED  
AUG 27 1992

WATER ANALYSIS REPORT  
TEXAS DEPARTMENT OF HEALTH  
DIVISION OF WATER HYGIENE  
1100 WEST 49 TH STREET  
AUSTIN, TEXAS 78756

FALLS CITY CITY OF  
P O BOX 250  
FALLS CITY TX 78113

WATER SUPPLY #: 1280004  
LABORATORY NO: EP204348  
SAMPLE TYPE: RAW SAMPLE

COLLECTOR REMARKS:  
SOURCE:

DATE COLLECTED 6/26/92 DATE RECEIVED 7/13/92 DATE REPORTED 8/19/92

CONSTITUENT NAME	RESULT	UNITS	+/-
CALCIUM	3	MG/L	
CHLORIDE	85	MG/L	
FLUORIDE	0.8	MG/L	
MAGNESIUM	< 1	MG/L	
NITRATE (AS N)	0.01	MG/L	
SODIUM	290	MG/L	
SULFATE	31	MG/L	
TOTAL HARDNESS/CAC03	9	MG/L	
PH	7.5		
DIL. CONDUCT (UMHOS/CM)	1287		
TOT. ALKA. AS CAC03	487	MG/L	
BICARBONATE	594	MG/L	
CARBONATE	0	MG/L	
DISSOLVED SOLIDS	705	MG/L	
P. ALKALINITY /CAC03	0	MG/L	
IRON	0.02	MG/L	
MANGANESE	< 0.02	MG/L	

RECEIVED  
01/21/91

WATER ANALYSIS REPORT  
TEXAS DEPARTMENT OF HEALTH  
DIVISION OF WATER HYGIENE  
1100 WEST 49 TH STREET  
AUSTIN, TEXAS 78756

FALLS CITY CITY OF  
P O BOX 250  
FALLS CITY TX 78113

WATER SUPPLY #: 1280004  
LABORATORY NO: EPO08245  
SAMPLE TYPE: DISTRIBUTION

COLLECTOR REMARKS:

SOURCE:

DATE COLLECTED 7/18/90 DATE RECEIVED 7/23/90 DATE REPORTED 1/10/91

CONSTITUENT NAME	RESULT	UNITS	+/-
CALCIUM	4	MG/L	
CHLORIDE	88	MG/L	
FLUORIDE	0.9	MG/L	
MAGNESIUM	< 1	MG/L	
NITRATE (AS N)	0.11	MG/L	
SODIUM	297	MG/L	
SULFATE	21	MG/L	
TOTAL HARDNESS/CAC03	11	MG/L	
FH	8.6		
EIL.CONDUCT(UMHOS/CM)	1340		
TOT. ALKA. AS CAC03	504	MG/L	
BICARBONATE	598	MG/L	
CARBONATE	8	MG/L	
DISSOLVED SOLIDS	716	MG/L	
F. ALKALINITY /CAC03	7	MG/L	
ARSENIC	< 0.025	MG/L	
BARIUM	0.078	MG/L	
CADMIUM	< 0.005	MG/L	
CHROMIUM	< 0.02	MG/L	
COPPER	< 0.02	MG/L	
IRON	< 0.02	MG/L	
LEAD	< 0.0050	MG/L	
MANGANESE	< 0.02	MG/L	
MERCURY	< 0.0002	MG/L	
SELENIUM	< 0.002	MG/L	
SILVER	< 0.010	MG/L	
ZINC	< 0.02	MG/L	

RECEIVED  
FEB 18 1994

WATER ANALYSIS REPORT  
TEXAS WATER COMMISSION  
MONITORING AND ENFORCEMENT SECTION  
WATER UTILITIES DIVISION  
P.O. BOX 13087  
AUSTIN, TEXAS 78711-3087

FALLS CITY CITY OF  
P O BOX 250  
FALLS CITY TX 78113

WATER SUPPLY #: 1280004  
LABORATORY NO: EP400420  
SAMPLE TYPE: RAW SAMPLE  
# 2

COLLECTOR REMARKS: CARRIZO SAND  
SOURCE: WELL #3 NEW  
ENTRY POINTS:

DATE COLLECTED 1/19/94 DATE RECEIVED 1/20/94 DATE REPORTED 2/ 2/94

CONSTITUENT NAME	RESULT	UNITS	+/-
CALCIUM	3	MG/L	
CHLORIDE	89	MG/L	
FLUORIDE	0.9	MG/L	
MAGNESIUM	1	MG/L	
NITRATE (AS N)	< 0.01	MG/L	
SODIUM	283	MG/L	
SULFATE	10	MG/L	
TOTAL HARDNESS/CAC03	10	MG/L	
PH	8.2		
DIL.CONDUCT(UMHOS/CM)	1233		
TGT. ALKA. AS CAC03	499	MG/L	
BICARBONATE	609	MG/L	
CARBONATE	0	MG/L	
DISSOLVED SOLIDS	690	MG/L	
P. ALKALINITY /CAC03	0	MG/L	

WATER ANALYSIS REPORT  
TEXAS WATER COMMISSION  
MONITORING AND ENFORCEMENT SECTION  
WATER UTILITIES DIVISION  
P.O. BOX 13087  
AUSTIN, TEXAS 78711-3087

FLORESVILLE, CITY OF  
C/O ROY SANCHEZ  
PO BOX 845  
FLORESVILLE TX 78114

WATER SUPPLY #: 2470001  
LABORATORY NO: EP307615  
SAMPLE TYPE:

COLLECTOR REMARKS:

SOURCE:

ENTRY POINTS: 003

DATE COLLECTED 10/11/93 DATE RECEIVED 10/15/93 DATE REPORTED 11/ 3/93

CONSTITUENT NAME	RESULT	UNITS	+/-
CALCIUM	44	MG/L	
CHLORIDE	41	MG/L	
FLUORIDE	0.8	MG/L	
MAGNESIUM	15	MG/L	
NITRATE (AS N)	0.21	MG/L	
SODIUM	68	MG/L	
SULFATE	50	MG/L	
TOTAL HARDNESS/CAC03	173	MG/L	
PH	8.0		
DIL.CONDUCT(UMHOS/CM)	675		
TOT. ALKA. AS CAC03	220	MG/L	
BICARBONATE	268	MG/L	
CARBONATE	0	MG/L	
DISSOLVED SOLIDS	362	MG/L	
P. ALKALINITY /CAC03	0	MG/L	

WATER ANALYSIS REPORT  
TEXAS WATER COMMISSION  
MONITORING AND ENFORCEMENT SECTION  
WATER UTILITIES DIVISION  
P.O. BOX 13087  
AUSTIN, TEXAS 78711-3087

FLOPESVILLE, CITY OF  
C/O ROY SANCHEZ  
PO BOX 845  
FLOPESVILLE TX 78114

WATER SUPPLY #: 2470001  
LABORATORY NO: EP307612  
SAMPLE TYPE:

COLLECTOR REMARKS:

SOURCE:

ENTRY POINTS: 002

DATE COLLECTED 10/11/93 DATE RECEIVED 10/15/93 DATE REPORTED 11/ 3/93

CONSTITUENT NAME	RESULT	UNITS	+/-
CALCIUM	40	MG/L	
CHLORIDE	39	MG/L	
FLUORIDE	1.1	MG/L	
MAGNESIUM	13	MG/L	
NITRATE (AS N)	0.07	MG/L	
SODIUM	79	MG/L	
SULFATE	51	MG/L	
TOTAL HARDNESS/CAC03	153	MG/L	
PH	8.1		
DIL. CONDUCT (UMHOS/CM)	698		
TOT. ALKA. AS CAC03	228	MG/L	
BICARBONATE	278	MG/L	
CARBONATE	0	MG/L	
DISSOLVED SOLIDS	369	MG/L	
P. ALKALINITY /CAC03	0	MG/L	

NOV 1993



WATER ANALYSIS REPORT  
 TEXAS DEPARTMENT OF HEALTH  
 DIVISION OF WATER HYGIENE  
 1100 WEST 49 TH STREET  
 AUSTIN, TEXAS 78756

KARNES CITY CITY OF  
 P O BOX 399  
 KARNES CITY TX 78118

WATER SUPPLY #: 1280001  
 LABORATORY NO: EP008668  
 SAMPLE TYPE: DISTRIBUTION

COLLECTOR REMARKS:

SOURCE:

DATE COLLECTED 7/30/90 DATE RECEIVED 8/ 9/90 DATE REPORTED 10/ 1/90

CONSTITUENT NAME	RESULT	UNITS	+/-
CALCIUM	7	MG/L	
CHLORIDE	94	MG/L	
FLUORIDE	1.2	MG/L	
MAGNESIUM	< 1	MG/L	
NITRATE (AS N)	< 0.01	MG/L	
SODIUM	317	MG/L	
SULFATE	24	MG/L	
TOTAL HARDNESS/CAC03	19	MG/L	
PH	8.2		
DIL. CONDUCT (UMHOS/CM)	1420		
TOT. ALKA. AS CAC03	548	MG/L	
BICARBONATE	669	MG/L	
CARBONATE	0	MG/L	
DISSOLVED SOLIDS	775	MG/L	
P. ALKALINITY /CAC03	0	MG/L	
ARSENIC	< 0.010	MG/L	
BARIUM	0.077	MG/L	
CADMIUM	< 0.005	MG/L	
CHROMIUM	< 0.02	MG/L	
COPPER	0.02	MG/L	
IRON	0.18 <del>1.14</del>	MG/L	0.18
LEAD	0.0070	MG/L	
MANGANESE	< 0.02	MG/L	
MERCURY	< 0.0002	MG/L	
SELENIUM	< 0.002	MG/L	
SILVER	< 0.010	MG/L	
ZINC	0.09	MG/L	

WATER ANALYSIS REPORT  
TEXAS DEPARTMENT OF HEALTH  
DIVISION OF WATER HYGIENE  
1100 WEST 49 TH STREET  
AUSTIN, TEXAS 78756

KARNES CITY CITY OF  
P O BOX 399  
KARNES CITY TX 78118

WATER SUPPLY #: 1280001  
LABORATORY NO: EP908191  
SAMPLE TYPE: DISTRIBUTION

COLLECTOR REMARKS:

SOURCE:

DATE COLLECTED 7/13/89 DATE RECEIVED 7/24/89 DATE REPORTED 11/ 1/89

CONSTITUENT NAME	RESULT	UNITS	+/-
Gross Alpha	< 2.00	pci/l	
Gross Beta	< 4.00	pci/l	

Texas Water Development Board  
**Chemical Water Analysis Report**

MISC JB-1990 070

TWDB Use Only	
Work No.	<u>320-3202</u>
IAC No.	_____

Send Reply To:  
Ground Water Unit  
Texas Water Development Board  
P.O. Box 13231  
Austin, Texas 78711

Citywell #3

Attention: ERIC ADIDAS

State Well Number: 7A-01-901

County: KARNES

Date & Time: 05-24-1990 11:15

Owner: CITY OF KARNES CITY

Send Copy To Owner

Address: BOX 399 KARNES CITY TX 78118

Sampled After Pumping: 1 1/2 Hours

Date Drilled: 1950 Depth: 872'

Yield: \_\_\_\_\_ GPM  Measured  Estimated

Collection Point: WELL HEAD pH 8.26

Use: Publics STANDBY Temperature: 33.1 °C

By: James St. Beaumont

Specific Conductance: 2380

Requested Chemicals: 

Laboratory No.: 1830-3219

Date Received: MAY 25 1990

Date Reported: JUL 31 1990

CODE 59170 ORGANICS SCREEN GC

SWN: 1101101  
 County: KARNES  
 Aquifer(s): \_\_\_\_\_

City Well #3  
 KARNES CITY

Sample No. 1101101  
 Date: 5-24-90  
 By: James R. Beumgard

	<u>Bottle 1</u>	<u>Bottle 2</u>	<u>Bottle 3</u>	<u>Bottle 4</u>	<u>Bottle 5</u>	<u>Bottle 6</u>	<u>Bottle 7</u>	<u>Total</u>
	1 liter Anions	1 liter Cations/HM	1 gallon Radioactivity	500 ml Nitrate/ Phosphate	1 Qt.(glass) (TOC) Organics	500 ml Cyanide	<b>RADON</b>	Sub-Samples
		2ml	6ml	2ml	unfiltered			All filtered unless otherwise stipulated. All on ice.
Preserve with:	..	HNO <sub>3</sub> (Nitric)	HNO <sub>3</sub> (Nitric)	H <sub>2</sub> SO <sub>4</sub> (Sulfuric)	..	NaOH (Sodium Hydroxide)		

Water Level \_\_\_\_\_ LSD  
 Temperature (00010) 33.1 °C  
 Specific Conductance (00094) 2380 µmhos/cm  
 pH (00400) 8.26  
 Eh (00090) -384.8 mv  
 Phenol ALK (82244) ∅ mg/l  
 Total ALK (00431) 256 mg/l  
 Carbonate (00452) ∅ meq/l ∅ mg/l  
 Bicarbonate (00453) 5.1 meq/l 312.4 mg/l  
 Total Cations (+) \_\_\_\_\_  
 Total Anions (-) \_\_\_\_\_  
 Total Hardness (48570) 17  
 Dissolved Solids (70301) 1361

AIR TEMP 32.0 °C Notes & Calculations TIME IN 10:05 AM  
 WEATHER COND Humid Warm Sunny TIME OUT 12:00 PM  
 PH CAL: PH = 4.01 @ 27.1 °C COND CAL: SC = 715 @ 715 SOL.  
 PH = 10.00 @ 27.0 °C SC = 1417 @ 1417 SOL.  
 TITRATION: PH = 8.27 AT START 31.5 <sup>check 7.00</sup> 4 DROPS PHENOL 8.10  
 PH = 8.05 AFTER BROMCRESOL 31.2 50 ML OF SAMPLE 31  
∅ ML H<sub>2</sub>SO<sub>4</sub> @ PH ∅ FOR CARBONATE IF PRESENT  
12.80 ML H<sub>2</sub>SO<sub>4</sub> @ PH 4.50 FOR BICARBONATE  
 REMARKS: very slight color change  
Pump Start POA 15 min 9:45 AM  
Radon Sampling Time 11:05 AM  
Sample Time 11:15 AM  
Sample Point Faucet at Well Head  
NOTE City Gets Water From EL-050 Well  
Stands by well

JORDAN LABORATORIES, INC.  
CHEMISTS AND ENGINEERS  
CORPUS CHRISTI, TEXAS  
JULY 5, 1990

TEXAS WATER DEVELOPMENT BOARD  
P.O. BOX 13231  
AUSTIN, TEXAS 78711-3231

REPORT OF ANALYSIS

RAD-JLB-1990-070

STATE WELL NUMBER: CITY WELL #3  
79-01-901  
DATE AND TIME: 11:15 5-24-90

COUNTY: KARNES

OWNER: CITY OF KARNES CITY

ADDRESS: BOX 399 KARNES CITY, TX 78118

DATE DRILLED: 1950

SAMPLED AFTER PUMPING 1 1/2 HRS.

DEPTH: 372'

YIELD: --- GPM

COLLECTION POINT: WELL HEAD

PH: 8.26

USE: PUBLIC S. TEMP.: 33.1 DEG.C.  
STANDBY

SPEC. COND.: 2380

		ANALYSIS DATE
POTASSIUM 40, PCI/L	----- 16	06-29-90
URANIUM (NATURAL), MG/L	----- <0.001	05-29-90
RADON 222, PCI/L	----- 17200*	05-25-90
COUNTING ERROR, PCI/L	----- +/- 100*	
RADIUM 226, PCI/L	----- 0.6	06-05-90
COUNTING ERROR, PCI/L	----- +/- 0.1	
THORIUM 232, PCI/L	----- -0.3	07-02-90
COUNTING ERROR, PCI/L	----- +/- 0.4	
RADIUM 228, PCI/L	----- -1.2	06-11-90
COUNTING ERROR, PCI/L	----- +/- 2.0	

\* VALUE REFLECTS RADON 222 CONTENT AS OF 11:05 AM 5-24-90.

LAB. NO. M28-3650

RESPECTFULLY SUBMITTED,

CARL F. CROWNOVER

Texas Water Development Board  
**Chemical Water Analysis Report**

GWR-JB-1990 070  
 (Anions)

TWDB Use Only	
Work No. <u>370-3702</u>	
IAC No. _____	

Send Reply To:  
 Ground Water Unit  
 Texas Water Development Board  
 P.O. Box 13231  
 Austin, Texas 78711

City Well #3

Attention: ERIC ADIDAS  
 County: KARNES  
 Owner: CITY OF KARNES CITY  
 Address: BOX 379 KARNES CITY TX 78118  
 Date Drilled: 1950 Depth: 872'  
 Collection Point: WELL HEAD pH 8.26  
 Analyst: Jane A. Beaulieu

State Well Number: 19-01-901  
 Date & Time: 05-24-1990 11:15  
 Send Copy To Owner  
 Sampled After Pumping: 1 1/2 Hours  
 Yield: \_\_\_\_\_ GPM  Measured  Estimated  
 Use: Publics STANBY Temperature: 33.1 °C  
 Specific Conductance: 2380

Requested Chemical Analysis: \_\_\_\_\_  
 Laboratory No.: EBO-1298 Date Received: MAY 25 1990 Date Reported: JUN 20 1990

Sample No.	Date Received	Date Reported			
HD-Sample No. EBO 1298	05/25/90	06/18/90			
Silica (00955)	MEQ/L	MG/L	MEQ/L	MG/L	
		79			
		Sulfate (00946)	1.85	83	
		Chloride (00941)	14.83	526	
		Fluoride (00950)	0.03	0.65	
Alkalinity (00415)	0.00	0			
Alkalinity (00410)	5.44	272			
		Iodide (71865)		( 0.1	
		Boron (*****)		2.78	
		Bromide (71870)		0.35	

**Texas Water Development Board**  
**Chemical Water Analysis Report**

GWN: JB PAO. 070  
 (Nitrogen Cycle)

TWDB Use Only	
Work No.	<u>320-3202</u>
IAC No.	_____

Send Reply To:  
 Ground Water Unit  
 Texas Water Development Board  
 P.O. Box 13231  
 Austin, Texas 78711

CITY Well #3

Attention: ERIC ADIDAS

State Well Number: 79-01-901

County: KARNES

Date & Time: 05-24-1990 11:15

Owner: CITY OF KARNES CITY

Send Copy To Owner

Address: BOX 379 KARNES CITY TX 78118

Sampled After Pumping: 1 1/2 Hours

Date Drilled: 1950 Depth: 872'

Yield: \_\_\_\_\_ GPM  Measured  Estimated

Collection Point: WELL HEAD pH 8.26

Use: Publics STANDBY Temperature: 33.1 °C

By: James A. Beaulieu

Specific Conductance: 2380

Requested Chem: \_\_\_\_\_  
 Laboratory No.: EB0-1348

Date Received: MAY 25 1990

Date Reported: JUN 1 1990

THD-Sample No. EB0 1348

Date Received 05/25/90

Date Reported 06/01/90

Nitrate as N (00618) 0.01 MG/L  
 KJE as N (00623) 0.2 MG/L

Ammonia as N (00608) 0.2 MG/L  
 Nitrite as N (00613) < 0.0 MG/L  
 Orthophosphate as P (00671) 0.0 MG/L

\*Note: To convert NO<sub>2</sub>-N to NO<sub>3</sub>, multiply by 4.427.

Texas Water Development Board  
**Chemical Water Analysis Report**

HM- JLB 1990. 070  
 HM = Heavy Trace and Alkaline-Earth Metals

NOTE: Suspended Solids  
constituents

TWDB Use Only	
Work No.	_____
IAC No.	_____

Send Reply To:  
 Ground Water Unit  
 Texas Water Development Board  
 P.O. Box 13231  
 Austin, Texas 78711

Attention: Eric Adidas  
 County: Karnes ~~Co~~  
 Owner: Karnes City  
 Address: \_\_\_\_\_  
 Date Drilled: \_\_\_\_\_ Depth: \_\_\_\_\_  
 Collection Point: Well head pH 8.26  
 By: EH - 384.8mV

State Well Number: 79 01 901  
city well # 3  
 Date & Time: 5/24/90  
 Send Copy To Owner  
 Sampled After Pumping: 1 1/2 Hours  
 Yield: \_\_\_\_\_ GPM  Measured  Estimated  
 Use: Public Supply Temperature: 33.1 °C  
Stand by  
 Specific Conductance: 2380 Air Temp 32.0 °C

Dissolve solids and analyze resulting solutions

Requested Chemicals: \_\_\_\_\_  
 Laboratory No.: EB-1399 Date Received: JUN 7 1990 Date Reported: JUL 16 1990

		me/l	<del>mg</del> µg			me/l	<del>mg</del> µg
Calcium	(00915)	_____	<u>90</u>	Sodium	(00930)	_____	<u>1710</u>
Magnesium	(00925)	_____	<u>14</u>	Potassium	(00935)	_____	<u>106</u>
Aluminum	(01106)	_____	<u>**</u>	Manganese	(01056)	_____	<u>25</u>
Arsenic	(01000)	_____	<u>&lt; 1</u>	Mercury	(71890)	_____	<u>NA</u>
Barium	(01005)	_____	<u>&lt; 2</u>	Molybdenum*	(01062)	_____	<u>&lt; 2</u>
Cadmium	(01025)	_____	<u>&lt; 1.0</u>	Selenium	(01145)	_____	<u>&lt; 2</u>
Chromium	(01030)	_____	<u>6.7</u>	Silver	(01075)	_____	<u>NA</u>
Copper	(01040)	_____	<u>10</u>	* Strontium*	(01080)	_____	<u>&lt; 20</u>
Iron	(01046)	_____	<u>2330</u>	Vanadium*	(01085)	_____	<u>&lt; 2</u>
Lead	(01049)	_____	<u>&lt; 5</u>	Zinc	(01090)	_____	<u>390</u>

~~\* Do not analyze unless it is checked.~~  
 Note: Crossout those elements not to be analyzed.

\* Low recoveries  
 \*\* All level low; g.c. unsatisfactory



Texas Water Development Board  
**Chemical Water Analysis Report**

HM-JLB 1970.070  
 HM = Heavy Trace and Alkaline-Earth Metals

TWDB Use Only

Work No. 320-3202

IAC No. \_\_\_\_\_

Send Reply To:  
 Ground Water Unit  
 Texas Water Development Board  
 P.O. Box 13231  
 Austin, Texas 78711

Attention: ERIC ADIDAS State Well Number: 79-01-901  
 County: KARNES Date & Time: 05-24-1990 11:15  
 Owner: CITY OF KARNES CITY  Send Copy To Owner  
 Address: BOX 399 KARNES CITY TX 78118 Sampled After Pumping: 1 1/2 Hours  
 Date Drilled: 1950 Depth: 872' Yield: \_\_\_\_\_ GPM  Measured  Estimated  
 Collection Point: WELL HEAD pH 8.26 Use: PUBLICS STANLEY Temperature: 33.1 °C  
 By: [Signature] Specific Conductance: 2380

Requested Chemical Analysis

Laboratory No.: [Redacted] Date Received: MAY 25 1990 Date Reported: JUL 3 1990

		me/l	mg/l			me/l	mg/l
Calcium	(00915)	_____	<u>6.8</u>	Sodium	(00930)	_____	<u>475</u>
Magnesium	(00925)	_____	<u>0.18</u>	Potassium	(00935)	_____	<u>22</u>
Aluminum	(01106)	<u>&lt;50</u>		Manganese	(01056)	<u>&lt;20</u>	
Arsenic	(01000)	<u>&lt;10</u>		Mercury	(71890)	<u>&lt;0.2</u>	
Barium	(01005)	<u>20</u>		<input checked="" type="checkbox"/> Molybdenum*	(01062)	<u>&lt;20</u>	
Cadmium	(01025)	<u>&lt;10</u>		Selenium	(01145)	<u>&lt;2</u>	
Chromium	(01030)	<u>&lt;20</u>		Silver	(01075)	<u>&lt;10</u>	
Copper	(01040)	<u>&lt;20</u>		<input checked="" type="checkbox"/> Strontium*	(01080)	<u>&lt;200</u>	
Iron	(01046)	<u>29</u>		<input checked="" type="checkbox"/> Vanadium*	(01085)	<u>&lt;20</u>	
Lead	(01049)	<u>&lt;50</u>		Zinc	(01090)	<u>&lt;20</u>	

\* Do not analyze unless it is checked.  
 Note: Crossout those elements not to be analyzed.

WATER ANALYSIS REPORT  
 TEXAS WATER COMMISSION  
 MONITORING AND ENFORCEMENT SECTION  
 WATER UTILITIES DIVISION  
 P.O. BOX 13087  
 AUSTIN, TEXAS 78711-3087

KENEDY, CITY OF  
 P O BOX 539  
 KENEDY TX 78119

WATER SUPPLY #: 1280002  
 LABORATORY NO: EP304150  
 SAMPLE TYPE:

COLLECTOR REMARKS:

SOURCE:

ENTRY POINTS: 001

DATE COLLECTED 6/25/93 DATE RECEIVED 7/ 2/93 DATE REPORTED 8/ 2/93

CONSTITUENT NAME	RESULT	UNITS	+/-
CALCIUM	113	MG/L	
CHLORIDE	728	MG/L	
FLUORIDE	0.9	MG/L	
MAGNESIUM	9	MG/L	
NITRATE (AS N)	2.21	MG/L	
SODIUM	511	MG/L	
SULFATE	154	MG/L	
TOTAL HARDNESS/CAC03	319	MG/L	
PH	7.5		
DIL.CONDUCT(UMHOS/CM)	3484		
TOT. ALKA. AS CAC03	265	MG/L	
BICARBONATE	323	MG/L	
CARBONATE	0	MG/L	
DISSOLVED SOLIDS	1707	MG/L	
P. ALKALINITY /CAC03	0	MG/L	

WATER ANALYSIS REPORT  
TEXAS WATER COMMISSION  
MONITORING AND ENFORCEMENT SECTION  
WATER UTILITIES DIVISION  
P.O. BOX 13087  
AUSTIN, TEXAS 78711-3087

KENEDY, CITY OF  
P O BOX 539  
KENEDY TX 78119

WATER SUPPLY #: 1280002  
LABORATORY NO: EP304153  
SAMPLE TYPE:

COLLECTOR REMARKS:

SOURCE:

ENTRY POINTS: 002

DATE COLLECTED 6/25/93 DATE RECEIVED 7/ 2/93 DATE REPORTED 8/ 2/93

CONSTITUENT NAME	RESULT	UNITS	+/-
CALCIUM	58	MG/L	
CHLORIDE	406	MG/L	
FLUORIDE	1.2	MG/L	
MAGNESIUM	5	MG/L	
NITRATE (AS N)	1.92	MG/L	
SODIUM	405	MG/L	
SULFATE	145	MG/L	
TOTAL HARDNESS/CAC03	164	MG/L	
PH	8.2		
DIL.CONDUCT(UMHOS/CM)	2464		
TOT. ALKA. AS CAC03	358	MG/L	
BICARBONATE	437	MG/L	
CARBONATE	0	MG/L	
DISSOLVED SOLIDS	1261	MG/L	
P. ALKALINITY /CAC03	0	MG/L	

WATER ANALYSIS REPORT  
 TEXAS WATER COMMISSION  
 MONITORING AND ENFORCEMENT SECTION  
 WATER UTILITIES DIVISION  
 P.O. BOX 13087  
 AUSTIN, TEXAS 78711-3087

KENEDY, CITY OF

P O BOX 539  
 KENEDY

TX 78119

WATER SUPPLY #: 1280002  
 LABORATORY NO: EP308511  
 SAMPLE TYPE: RAW SAMPLE

COLLECTOR REMARKS:  
 SOURCE:

ENTRY POINTS:

DATE COLLECTED 11/12/93    DATE RECEIVED 11/12/93    DATE REPORTED 2/ 2/94

CONSTITUENT NAME	RESULT	UNITS	+/-
ALUMINUM	0.156	MG/L	
ARSENIC	0.0915	MG/L	
BARIUM	0.0406	MG/L	
CADMIUM	< 0.0001	MG/L	
CHROMIUM	0.0064	MG/L	
COPPER	0.0064	MG/L	
IRON	0.1710	MG/L	
MANGANESE	0.0111	MG/L	
MERCURY	0.00022	MG/L	
NICKEL	< 0.0050	MG/L	
SELENIUM	< 0.0040	MG/L	
SILVER	< 0.0100	MG/L	
ANTIMONY	< 0.0020	MG/L	
BERYLLIUM	< 0.0008	MG/L	
ZINC	0.0078	MG/L	

WATER ANALYSIS REPORT  
 TEXAS WATER COMMISSION  
 MONITORING AND ENFORCEMENT SECTION  
 WATER UTILITIES DIVISION  
 P.O. BOX 13087  
 AUSTIN, TEXAS 78711-3087

KENEDY, CITY OF  
 P O BOX 539  
 KENEDY TX 78119

WATER SUPPLY #: 1280002  
 LABORATORY NO: EP308510  
 SAMPLE TYPE: RAW SAMPLE

## COLLECTOR REMARKS:

SOURCE:

ENTRY POINTS:

DATE COLLECTED 11/12/93 DATE RECEIVED 11/12/93 DATE REPORTED 12/29/93

CONSTITUENT NAME	RESULT	UNITS	+/-
CALCIUM	51	MG/L	
CHLORIDE	330	MG/L	
FLUORIDE	1.2	MG/L	
MAGNESIUM	4	MG/L	
NITRATE (AS N)	1.47	MG/L	
SODIUM	364	MG/L	
SULFATE	122	MG/L	
TOTAL HARDNESS/CAC03	146	MG/L	
PH	6.5		
DIL.CONDUCT (UMHOS/CM)	2144		
TOT. ALKA. AS CAC03	365	MG/L	
BICARBONATE	445	MG/L	
CARBONATE	0	MG/L	
DISSOLVED SOLIDS	1118	MG/L	
P. ALKALINITY /CAC03	0	MG/L	



FINAL ANALYSIS REPORT

LAB ID: 9402012

SAMPLE TYPE: Water

FACILITY: GBRA

ORIGINAL DATE REPORTED: 03/25/94

ACCT NO: GBRA P.O. BOX 271 SEGUIN, TX 78156

DATE RECEIVED: 01/19/94

SAMPLE DATE: 01/13/94

SAMPLE TIME: 1100

DEPTH:

LOCATION ID: KENEDY WELL #10

PARAMETER	RESULTS	UNITS	METHOD #	PQL in WATER	DATE ANALYZED
Arsenic, Total-AA	.077.1	ug/L	EPA206.2	10	03/18/94
Arsenic (III)	70.6	ug/L	SM3500	10	03/25/94
Arsenic (V)	<10.0	ug/L	SM3500	10	03/25/94

*Buck Henderson*

BUCK HENDERSON  
LABORATORY MANAGER



This report shall not be reproduced except in full, without the written approval of the laboratory management.

**POLLUTION CONTROL SERVICES**

435 Isom Road, Suite 228

San Antonio, TX 78216

(210) 340-0343

**REPORT OF SAMPLE ANALYSIS**

To: Alex Hernandez  
 City of Pearsall  
 213 S.Oak St.  
 Pearsall, TX 78061

**CLIENT INFORMATION**

**LABORATORY INFORMATION**

**Project Name:**  
**Sample ID:** CHERRY PLANT  
**Date Taken:** 4/6/93  
**Time Taken:**

**PCS Sample #:** 27978  
**Date Rec'd:** 4/6/93  
**Time Rec'd:** 1400  
**Report Date:** 4/13/93

<u>TEST DESCRIPTION</u>	<u>SAMPLE RESULT</u>	<u>UNITS</u>	<u>DATE ANALYZED</u>	<u>METHOD USED</u>
pH	7.4	S.U.	4/6/93	4500-H+ B
Conductivity, Specific	650	umhos/cm	4/6/93	120.1
Total Dissolved Solids	396	mg/L	4/7/93	160.1
Iron	6.97	mg/L	4/13/93	200.7/6010
Calcium	88	mg/L	4/7/93	200.7/6010
Magnesium	13	mg/L	4/7/93	200.7/6010
Hardness as CaCO3	272	mg/L	4/7/93	330.2
Sodium	29	mg/L	4/8/93	200.7
Manganese	0.11	mg/L	4/13/93	200.7/6010
Alkalinity, Total	248	mg/L	4/7/93	310.1
Alkalinity, Bicarbonate	303	mg/L	4/7/93	2320 B
Sulfate	59	mg/L	4/8/93	4500-SO4 E
Chloride	27	mg/L	4/7/93	4500-Cl B
Fluoride	0.46	mg/L	4/8/93	340.1
Nitrate-N	0.069	mg/L	4/8/93	352.1

Approved by:

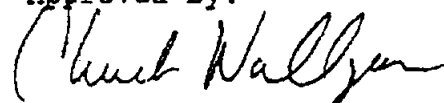

Chuck Wallgren  
 Owner

**POLLUTION CONTROL SERVICES**

435 Isom Road, Suite 228

San Antonio, TX 78216

(210) 340-0343

**REPORT OF SAMPLE ANALYSIS**

To: Alex Hernandez  
 City of Pearsall  
 213 S.Oak St.  
 Pearsall, TX 78061

**CLIENT INFORMATION**

**LABORATORY INFORMATION**

**Project Name:**  
**Sample ID:** COLORADO PLANT  
**Date Taken:** 4/6/93  
**Time Taken:**

**PCS Sample #:** 27979  
**Date Rec'd:** 4/6/93  
**Time Rec'd:** 1400  
**Report Date:** 4/13/93

<u>TEST DESCRIPTION</u>	<u>SAMPLE RESULT</u>	<u>UNITS</u>	<u>DATE ANALYZED</u>	<u>METHOD USED</u>
pH	7.4	S.U.	4/6/93	4500-H+ B
Conductivity, Specific	610	umhos/cm	4/6/93	120.1
Total Dissolved Solids	392	mg/L	4/7/93	160.1
Iron	0.22	mg/L	4/13/93	200.7/6010
Calcium	88	mg/L	4/7/93	200.7/6010
Magnesium	15	mg/L	4/7/93	200.7/6010
Hardness as CaCO3	280	mg/L	4/7/93	330.2
Sodium	30	mg/L	4/8/93	200.7
Manganese	0.01	mg/L	4/13/93	200.7/6010
Alkalinity, Total	248	mg/L	4/7/93	310.1
Alkalinity, Bicarbonate	303	mg/L	4/7/93	2320 B
Sulfate	61	mg/L	4/8/93	4500-SO4 E
Chloride	27	mg/L	4/7/93	4500-Cl B
Fluoride	0.48	mg/L	4/8/93	340.1
Nitrate-N	0.075	mg/L	4/8/93	352.1

Approved by:

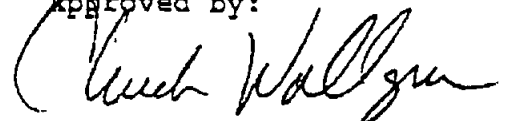

Chuck Wallgren  
 Owner



**POLLUTION CONTROL SERVICES**

435 Isom Road, Suite 228

San Antonio, TX 78216

(210) 340-0343

**REPORT OF SAMPLE ANALYSIS**

To: Alex Hernandez  
 City of Pearsall  
 213 S.Oak St.  
 Pearsall, TX 78061

**CLIENT INFORMATION**

**LABORATORY INFORMATION**

**Project Name:**  
**Sample ID:** NORTH PLANT  
**Date Taken:** 4/6/93  
**Time Taken:**

**PCS Sample #:** 27980  
**Date Rec'd:** 4/6/93  
**Time Rec'd:** 1400  
**Report Date:** 4/13/93

<u>TEST DESCRIPTION</u>	<u>SAMPLE RESULT</u>	<u>UNITS</u>	<u>DATE ANALYZED</u>	<u>METHOD USED</u>
pH	7.4	S.U.	4/6/93	4500-H+ B
Conductivity, Specific	610	umhos/cm	4/6/93	120.1
Total Dissolved Solids	376	mg/L	4/7/93	160.1
Iron	1.36	mg/L	4/13/93	200.7/6010
Calcium	83	mg/L	4/7/93	200.7/6010
Magnesium	14	mg/L	4/7/93	200.7/6010
Hardness as CaCO3	264	mg/L	4/7/93	330.2
Sodium	30	mg/L	4/8/93	200.7
Manganese	0.03	mg/L	4/13/93	200.7/6010
Alkalinity, Total	244	mg/L	4/7/93	310.1
Alkalinity, Bicarbonate	298	mg/L	4/7/93	2320 B
Sulfate	57	mg/L	4/8/93	4500-SO4 E
Chloride	26	mg/L	4/7/93	4500-Cl B
Fluoride	0.43	mg/L	4/8/93	340.1
Nitrate-N	0.088	mg/L	4/8/93	352.1

Approved by:

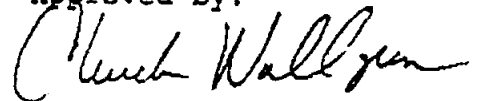

Chuck Wallgren  
 Owner

**P O L L U T I O N   C O N T R O L   S E R V I C E S**

435 Isom Road, Suite 228

San Antonio, TX 78216

(210) 340-0343

**REPORT OF SAMPLE ANALYSIS**

To: Alex Hernandez  
 City of Pearsall  
 213 S.Oak St.  
 Pearsall, TX 78061

**CLIENT INFORMATION**

**LABORATORY INFORMATION**

**Project Name:**  
**Sample ID:** EAST PLANT  
**Date Taken:** 4/6/93  
**Time Taken:**

**PCS Sample #:** 27981  
**Date Rec'd:** 4/6/93  
**Time Rec'd:** 1400  
**Report Date:** 4/13/93

<u>TEST DESCRIPTION</u>	<u>SAMPLE RESULT</u>	<u>UNITS</u>	<u>DATE ANALYZED</u>	<u>METHOD USED</u>
pH	7.3	S.U.	4/6/93	4500-H+ B
Conductivity, Specific	600	umhos/cm	4/6/93	120.1
Total Dissolved Solids	368	mg/L	4/7/93	160.1
Iron	0.18	mg/L	4/13/93	200.7/6010
Calcium	82	mg/L	4/7/93	200.7/6010
Magnesium	12	mg/L	4/7/93	200.7/6010
Hardness as CaCO3	252	mg/L	4/7/93	330.2
Sodium	30	mg/L	4/8/93	200.7
Manganese	0.02	mg/L	4/13/93	200.7/6010
Alkalinity, Total	244	mg/L	4/7/93	310.1
Alkalinity, Bicarbonate	298	mg/L	4/7/93	2320 B
Sulfate	57	mg/L	4/8/93	4500-SO4 E
Chloride	25	mg/L	4/7/93	4500-Cl B
Fluoride	0.50	mg/L	4/8/93	340.1
Nitrate-N	0.06	mg/L	4/8/93	352.1

Approved by:

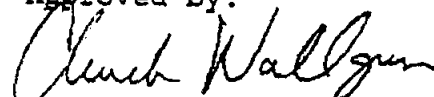

Chuck Wallgren  
 Owner

WATER ANALYSIS REPORT  
TEXAS WATER COMMISSION  
MONITORING AND ENFORCEMENT SECTION  
WATER UTILITIES DIVISION  
P.O. BOX 13087  
AUSTIN, TEXAS 78711-3087

PLEASANTON CITY OF

PO BOX 209  
PLEASANTON

TX 78064

WATER SUPPLY #: 0070003  
LABORATORY NO: EP300657  
SAMPLE TYPE:

COLLECTOR REMARKS:

SOURCE:

ENTRY POINTS: 001

DATE COLLECTED 3/ 2/93 DATE RECEIVED 3/ 5/93 DATE REPORTED 8/26/93

CONSTITUENT NAME	RESULT	UNITS	+/-
ALUMINUM	< 0.020	MG/L	
ARSENIC	< 0.0020	MG/L	
BARIUM	0.1930	MG/L	
CADMIUM	< 0.0001	MG/L	
CHROMIUM	< 0.0040	MG/L	
COPPER	0.1060	MG/L	
IRON	0.3520	MG/L	
MANGANESE	0.0291	MG/L	
MERCURY	< 0.00013	MG/L	
NICKEL	0.0057	MG/L	
SELENIUM	< 0.0020	MG/L	
SILVER	< 0.0030	MG/L	
ANTIMONY	< 0.0020	MG/L	
BERYLLIUM	< 0.0003	MG/L	
ZINC	0.0244	MG/L	

WATER ANALYSIS REPORT  
TEXAS WATER COMMISSION  
MONITORING AND ENFORCEMENT SECTION  
WATER UTILITIES DIVISION  
P.O. BOX 13087  
AUSTIN, TEXAS 78711-3087

PLEASANTON CITY OF  
PO BOX 209  
PLEASANTON TX 78064

WATER SUPPLY #: 0070003  
LABORATORY NO: EP300656  
SAMPLE TYPE:

COLLECTOR REMARKS:

SOURCE:

ENTRY POINTS: 001

DATE COLLECTED 3/ 2/93 DATE RECEIVED 3/ 5/93 DATE REPORTED 4/21/93

CONSTITUENT NAME	RESULT	UNITS	+/-
CALCIUM	12	MG/L	
CHLORIDE	105	MG/L	
FLUORIDE	0.4	MG/L	
MAGNESIUM	4	MG/L	
NITRATE (AS N)	0.02	MG/L	
SODIUM	171	MG/L	
SULFATE	9	MG/L	
TOTAL HARDNESS/CAC03	48	MG/L	
PH	8.2		
DIL.CONDUCT(UMHOS/CM)	906		
TOT. ALKA. AS CAC03	272	MG/L	
BICARBONATE	332	MG/L	
CARBONATE	0	MG/L	
DISSOLVED SOLIDS	468	MG/L	
P. ALKALINITY /CAC03	0	MG/L	

WATER ANALYSIS REPORT  
TEXAS WATER COMMISSION  
MONITORING AND ENFORCEMENT SECTION  
WATER UTILITIES DIVISION  
P.O. BOX 13087  
AUSTIN, TEXAS 78711-3087

PLEASANTON CITY OF

PO BOX 209

PLEASANTON

TX

78064

WATER SUPPLY #: 0070003

LABORATORY NO: EP300660

SAMPLE TYPE:

COLLECTOR REMARKS:

SOURCE:

ENTRY POINTS: 002

DATE COLLECTED 3/ 2/92 DATE RECEIVED 3/ 5/93 DATE REPORTED 8/26/93

CONSTITUENT NAME	RESULT	UNITS	+/-
ALUMINUM	< 0.020	MG/L	
ARSENIC	< 0.0020	MG/L	
BARIUM	0.2300	MG/L	
CADMIUM	< 0.0001	MG/L	
CHROMIUM	< 0.0040	MG/L	
COPPER	0.0050	MG/L	
IRON	0.0887	MG/L	
MANGANESE	0.0040	MG/L	
MERCURY	< 0.00013	MG/L	
NICKEL	0.0065	MG/L	
SELENIUM	< 0.0020	MG/L	
SILVER	0.0030	MG/L	
ANTIMONY	< 0.0020	MG/L	
BERYLLIUM	< 0.0003	MG/L	
ZINC	< 0.0050	MG/L	

WATER ANALYSIS REPORT  
TEXAS WATER COMMISSION  
MONITORING AND ENFORCEMENT SECTION  
WATER UTILITIES DIVISION  
P.O. BOX 13087  
AUSTIN, TEXAS 78711-3087

PLEASANTON CITY OF  
PO BOX 209  
PLEASANTON TX 78064

WATER SUPPLY #: 0070003  
LABORATORY NO: EP300659  
SAMPLE TYPE:

COLLECTOR REMARKS:

SOURCE:

ENTRY POINTS: 002

DATE COLLECTED 3/ 2/93 DATE RECEIVED 3/ 5/93 DATE REPORTED 4/21/93

CONSTITUENT NAME	RESULT	UNITS	+/-
CALCIUM	12	MG/L	
CHLORIDE	93	MG/L	
FLUORIDE	0.5	MG/L	
MAGNESIUM	5	MG/L	
NITRATE (AS N)	0.02	MG/L	
SODIUM	159	MG/L	
SULFATE	4	MG/L	
TOTAL HARDNESS/CAC03	51	MG/L	
PH	8.0		
DIL.CONDUCT(UMHOS/CM)	846		
TOT. ALKA. AS CAC03	272	MG/L	
BICARBONATE	332	MG/L	
CARBONATE	0	MG/L	
DISSOLVED SOLIDS	441	MG/L	
P. ALKALINITY /CAC03	0	MG/L	

WATER ANALYSIS REPORT  
TEXAS WATER COMMISSION  
MONITORING AND ENFORCEMENT SECTION  
WATER UTILITIES DIVISION  
P.O. BOX 13087  
AUSTIN, TEXAS 78711-3087

PLEASANTON CITY OF

PO BOX 209

PLEASANTON TX 78064

WATER SUPPLY #: 0070003

LABORATORY NO: EP300663

SAMPLE TYPE:

COLLECTOR REMARKS:

SOURCE:

ENTRY POINTS: 003

DATE COLLECTED 3/ 2/93 DATE RECEIVED 3/ 5/93 DATE REPORTED 8/26/93

CONSTITUENT NAME	RESULT	UNITS	+/-
ALUMINUM	< 0.020	MG/L	
ARSENIC	< 0.0020	MG/L	
BARIUM	0.0838	MG/L	
CADMIUM	< 0.0001	MG/L	
CHROMIUM	< 0.0040	MG/L	
COPPER	< 0.0020	MG/L	
IRON	0.1780	MG/L	
MANGANESE	0.0043	MG/L	
MERCURY	< 0.00013	MG/L	
NICKEL	0.0069	MG/L	
SELENIUM	< 0.0020	MG/L	
SILVER	< 0.0030	MG/L	
ANTIMONY	< 0.0020	MG/L	
BERYLLIUM	< 0.0003	MG/L	
ZINC	0.0097	MG/L	

WATER ANALYSIS REPORT  
TEXAS WATER COMMISSION  
MONITORING AND ENFORCEMENT SECTION  
WATER UTILITIES DIVISION  
P.O. BOX 13087  
AUSTIN, TEXAS 78711-3087

PLEASANTON CITY OF  
PO BOX 209  
PLEASANTON TX 78064

WATER SUPPLY #: 0070003  
LABORATORY NO: EP300662  
SAMPLE TYPE:

COLLECTOR REMARKS:

SOURCE:

ENTRY POINTS: 003

DATE COLLECTED 3/ 2/93 DATE RECEIVED 3/ 5/93 DATE REPORTED 4/21/93

CONSTITUENT NAME	RESULT	UNITS	+/-
CALCIUM	37	MG/L	
CHLORIDE	100	MG/L	
FLUORIDE	0.6	MG/L	
MAGNESIUM	18	MG/L	
NITRATE (AS N)	0.02	MG/L	
SODIUM	123	MG/L	
SULFATE	61	MG/L	
TOTAL HARDNESS/CAC03	167	MG/L	
PH	7.9		
DIL.CONDUCT(UMH0S/CM)	980		
TOT. ALKA. AS CAC03	253	MG/L	
BICARBONATE	309	MG/L	
CARBONATE	0	MG/L	
DISSOLVED SOLIDS	501	MG/L	
P. ALKALINITY /CAC03	0	MG/L	



WATER ANALYSIS REPORT  
TEXAS WATER COMMISSION  
MONITORING AND ENFORCEMENT SECTION  
WATER UTILITIES DIVISION  
P.O. BOX 13087  
AUSTIN, TEXAS 78711-3087

PLEASANTON CITY OF

PO BOX 209  
PLEASANTON TX 78064

WATER SUPPLY #: 0070003  
LABORATORY NO: EP300666  
SAMPLE TYPE:

COLLECTOR REMARKS:

SOURCE:

ENTRY POINTS: 004

DATE COLLECTED 3/ 2/93 DATE RECEIVED 3/ 5/93 DATE REPORTED 8/26/93

CONSTITUENT NAME	RESULT	UNITS	+/-
ALUMINUM	0.060	MG/L	
ARSENIC	< 0.0020	MG/L	
BARIUM	0.1700	MG/L	
CADMIUM	< 0.0001	MG/L	
CHROMIUM	< 0.0040	MG/L	
COPPER	0.1010	MG/L	
IRON	2.6800	MG/L	
MANGANESE	0.1380	MG/L	
MERCURY	< 0.00013	MG/L	
NICKEL	0.0057	MG/L	
SELENIUM	< 0.0020	MG/L	
SILVER	< 0.0030	MG/L	
ANTIMONY	< 0.0020	MG/L	
BEPYLLIUM	< 0.0003	MG/L	
ZINC	0.3420	MG/L	

WATER ANALYSIS REPORT  
 TEXAS WATER COMMISSION  
 MONITORING AND ENFORCEMENT SECTION  
 WATER UTILITIES DIVISION  
 P.O. BOX 13087  
 AUSTIN, TEXAS 78711-3087

PLEASANTON CITY OF  
 PO BOX 209  
 PLEASANTON TX 78064

WATER SUPPLY #: 0070003  
 LABORATORY NO: EP300665  
 SAMPLE TYPE:

COLLECTOR REMARKS:  
 SOURCE:

ENTRY POINTS: 004

DATE COLLECTED 3/ 2/93    DATE RECEIVED 3/ 5/93    DATE REPORTED 4/21/93

CONSTITUENT NAME	RESULT	UNITS	+/-
CALCIUM	46	MG/L	
CHLORIDE	129	MG/L	
FLUORIDE	0.4	MG/L	
MAGNESIUM	25	MG/L	
NITRATE (AS N)	0.04	MG/L	
SODIUM	148	MG/L	
SULFATE	142	MG/L	
TOTAL HARDNESS/CAC03	218	MG/L	
PH	8.0		
DIL. CONDUCT (UMH0S/CM)	1269		
TOT. ALKA. AS CAC03	227	MG/L	
BICARBONATE	277	MG/L	
CARBONATE	0	MG/L	
DISSOLVED SOLIDS	633	MG/L	
P. ALKALINITY /CAC03	0	MG/L	

WATER ANALYSIS REPORT  
TEXAS WATER COMMISSION  
MONITORING AND ENFORCEMENT SECTION  
WATER UTILITIES DIVISION  
P.O. BOX 13087  
AUSTIN, TEXAS 78711-2087

PLEASANTON CITY CF

WATER SUPPLY #: 0070003

PO BOX 209

LABORATORY NO: EP300672

PLEASANTON

TX

78064

SAMPLE TYPE:

COLLECTOR REMARKS:

SOURCE:

ENTRY POINTS: 005

DATE COLLECTED 3/ 2/93 DATE RECEIVED 3/ 5/93 DATE REPORTED 9/ 9/93

CONSTITUENT NAME	RESULT	UNITS	+/-
ALUMINUM	< 0.020	MG/L	
ARSENIC	< 0.0010	MG/L	
BARIUM	0.0858	MG/L	
CADMIUM	< 0.0001	MG/L	
CHROMIUM	< 0.0040	MG/L	
COPPER	0.0025	MG/L	
IRON	0.2730	MG/L	
MANGANESE	0.0063	MG/L	
MERCURY	< 0.00013	MG/L	
NICKEL	< 0.0050	MG/L	
SELENIUM	< 0.0020	MG/L	
SILVER	< 0.0030	MG/L	
ANTIMONY	< 0.0020	MG/L	
BERYLLIUM	< 0.0003	MG/L	
ZINC	< 0.0050	MG/L	

WATER ANALYSIS REPORT  
TEXAS WATER COMMISSION  
MONITORING AND ENFORCEMENT SECTION  
WATER UTILITIES DIVISION  
P.O. BOX 13037  
AUSTIN, TEXAS 78711-3087

PLEASANTON CITY OF  
PO BOX 209  
PLEASANTON TX 76064

WATER SUPPLY #: 0070003  
LABORATORY NO: EP300671  
SAMPLE TYPE:

COLLECTOR REMARKS:

SOURCE:

ENTRY POINTS: GJS

DATE COLLECTED 3/ 2/93 DATE RECEIVED 3/ 5/93 DATE REPORTED 4/21/93

CONSTITUENT NAME	RESULT	UNITS	+/-
CALCIUM	32	MG/L	
CHLORIDE	107	MG/L	
FLUORIDE	0.5	MG/L	
MAGNESIUM	16	MG/L	
NITRATE (AS N)	0.03	MG/L	
SODIUM	126	MG/L	
SULFATE	58	MG/L	
TOTAL HARDNESS/CAC03	147	MG/L	
PH	7.7		
DIL. CONDUCT (UMHOS/CM)	966		
TOT. ALKA. AS CAC03	229	MG/L	
BICARBONATE	279	MG/L	
CARBONATE	0	MG/L	
DISSOLVED SOLIDS	485	MG/L	
P. ALKALINITY /CAC03	0	MG/L	

WATER ANALYSIS REPORT  
 TEXAS DEPARTMENT OF HEALTH  
 DIVISION OF WATER HYGIENE  
 1100 WEST 49 TH STREET  
 AUSTIN, TEXAS 78756

RUNGE CITY OF

P O BOX 206  
 RUNGE TX 78151

WATER SUPPLY #: 1280003  
 LABORATORY NO: EP007286  
 SAMPLE TYPE: DISTRIBUTION

COLLECTOR REMARKS:

SOURCE:

DATE COLLECTED 6/11/90 DATE RECEIVED 6/14/90 DATE REPORTED 8/ 2/90

CONSTITUENT NAME	RESULT	UNITS	+/-
Calcium	130	mg/l	
Chloride	328	mg/l	
Fluoride	0.7	mg/l	
Magnesium	29	mg/l	
Nitrate (as N)	< 0.01	mg/l	
Sodium	131	mg/l	
Sulfate	38	mg/l	
Total Hardness/CaCO3	442	mg/l	
pH	7.7		
Dil. Conduct (umhos/cm)	1705		
Tot. Alka. as CaCO3	230	mg/l	
Bicarbonate	281	mg/l	
Carbonate	0	mg/l	
Dissolved solids	802	mg/l	
P. Alkalinity /CaCO3	0	mg/l	
Arsenic	< 0.010	mg/l	
Barium	0.154	mg/l	
Cadmium	< 0.005	mg/l	
Chromium	< 0.02	mg/l	
Copper	< 0.02	mg/l	
Iron	0.12	mg/l	
Lead	< 0.0200	mg/l	
Manganese	< 0.02	mg/l	
Mercury	< 0.0002	mg/l	
Selenium	0.004	mg/l	
Silver	< 0.010	mg/l	
Zinc	0.22	mg/l	

**APPENDIX C**

**COST ANALYSES**

**Appendix C-1**

**PARTICIPATING MUNICIPALITY  
COST TO MAINTAIN CURRENT  
RATED CAPACITIES THROUGH YEAR 2020**

	<u>UNIT</u>	<u>QUANT.</u>	<u>UNIT COST</u>	<u>TOTAL</u>
<b>FALLS CITY</b>				
Water Well	EA	1	138,000	138,000
Ground Storage	EA	1	83,000	83,000
Treatment (Auction)	EA	1	20,000	20,000
High Service Pumping	EA	3	5,000	15,000
Pressure Maintenance	EA	0	-	-
Distribution Lines	EA	0	-	-
Subtotal				\$ 256,000
Contingencies				<u>102,000</u>
Total Project Cost				\$ 358,000
<b>FLORESVILLE</b>				
Water Well	EA	1	120,000	120,000
Ground Storage	EA	1	138,000	138,000
Treatment (Auction)	EA	0	-	-
High Service Pumping	EA	8	10,000	80,000
Pressure Maintenance	EA	0	-	-
Distribution Lines	LF	0	-	-
Subtotal				\$ 328,000
Contingencies, Engineering, etc.				<u>135,000</u>
Total Project Cost				\$ 473,000
<b>KARNES CITY</b>				
Water Well	EA	3	80,000	240,000
Ground Storage	EA	0	-	-
Treatment (Auction)	EA	0	-	-
High Service Pumping	EA	4	5,000	20,000
Pressure Maintenance	EA	0	-	-
Distribution Lines	LF	0	-	-
Subtotal				\$ 260,000
Contingencies, Engineering, etc.				<u>104,000</u>
Total Project Cost				\$ 364,000
<b>KENEDY</b>				
Water Well	EA	5	80,000	400,000
Ground Storage	EA	0	-	-
Treatment (Auction)	EA	26	10,000	260,000
High Service Pumping	EA	3	5,000	15,000
Pressure Maintenance	EA	0	-	-
Distribution Lines	LF	0	-	-
Subtotal				\$ 675,000

Contingencies, Engineering, etc.				<u>270,000</u>
Total Project Cost				\$ 945,000

**PEARSALL**

Water Well	EA	3	215,000	645,000
Ground Storage	EA	1	38,000	38,000
Treatment(Auction)	EA	0	-	-
High Service Pumping	EA	7	10,000	70,000
Pressure Maintenance	EA	0	-	-
Distribution Lines	LF	0	-	-

Subtotal				\$ 753,000
Contingencies, Engineering, etc.				<u>301,000</u>
Total Project Cost				\$ 1,054,000

**PLEASANTON**

Water Well	EA	5	110,000	550,000
Ground Storage	EA	1	30,000	30,000
Treatment (Auction)	EA	0	-	-
High Service Pumping	EA	9	10,000	90,000
Pressure Maintenance	EA	0	-	-
Distribution Lines	LF	0	-	-

Subtotal				\$ 670,000
Contingencies, Engineering, etc.				<u>268,000</u>
Total Project Cost				\$ 938,000

**RUNGE**

Water Well	EA	2	140,000	550,000
Ground Storage	EA	0	-	-
Treatment (Auction)	EA	0	-	-
High Service Pumping	EA	3	5,000	15,000
Pressure Maintenance	EA	0	-	-
Distribution Lines	LF	0	-	-

Subtotal				\$ 155,000
Contingencies, Engineering, etc.				<u>62,000</u>
Total Project Cost				\$ 217,000



Appendix C-2

PARTICIPATING MUNICIPALITY  
COST TO MEET FUTURE  
SUPPLY, TREATMENT, PUMPING AND STORAGE NEEDS  
THROUGH YEAR 2020

FALLS CITY

- \* No additional Facilities Anticipated

FLORESVILLE

- \* 1800 gpm High Service Pump (1995) 20,000
- \* 200,000 Gal. Ground Storage Tank (2010) 100,000
- \* 250,000 Gal. Electrical Storage Tank (2010) 300,000

Subtotal 420,000  
Contingencies, Engineering, etc. 168,000  
Total Cost \$ 588,000

KARNES CITY

- \* 400 gpm High Service Pump (2000) 5,000

Subtotal 5,000  
Contingencies, Engineering, etc. 2,000  
Total Cost \$ 7,000

KENEDY

- \* Reverse Osmosis Ground Water Treatment (1995) 350,000
- \* 400 gpm High Service Pump (1995) 5,000
- \* 400 gpm High Service Pump (2020) 5,000

Subtotal 360,000  
Contingencies, Engineering, etc. 144,000  
Total Cost \$ 504,000

PEARSALL

- \* 750 gpm High Service Pump (2010) 10,000
- \* 750 gpm High Service Pump (2010) 10,000
- \* 1000 gpm Well (2015) 210,000

Subtotal 235,000  
Contingencies, Engineering, etc. 94,000  
Total Cost \$ 224,000

RUNGE

- \* Improve Water Quality (1995) 80,000
- \* 100 gpm Well (2020) 80,000

Subtotal 160,000  
Contingencies, Engineering, etc. 64,000  
Total Cost \$ 224,000

**Appendix C-3**

**REGION A  
PRELIMINARY ESTIMATE OF TOTAL PROJECT COSTS**

16" LINE	73,200 LF @ \$16/LF	1,171,200
8" LINE	11,100 LF @ \$8/LF	88,800
18" LINE	93,100 LF @ \$18/LF	1,675,800
16" LINE	41,200 LF @ \$16/LF	659,200
12" LINE	26,800 LF @ \$12/LF	321,600
8" LINE	53,500 LF @ \$8/LF	428,000

Stockdate Booster Station 2-800 gpm pumps	2 @ 10,000/Ea	20,000
--	---------------	--------

Floresville Booster Station 2-3200 gpm pumps	2 @ 30,000/Ea	60,000
---	---------------	--------

Poth Booster Station 2-3200 gpm pumps	2 @ 30,000/Ea	60,000
--	---------------	--------

Falls City Booster Station 2-3200 gpm pumps	2 @ 30,000/Ea	<u>60,000</u>
--	---------------	---------------

Subtotal Construction Cost      \$    4,544,600

Contingencies	682,000
Engineering	364,000
Surveying	299,000
Geotechnical	20,000
Inspection	100,000
Land Acquisition	100,000
Legal and Fiscal	<u>153,000</u>

Subtotal      \$    1,718,000

Total Project Costs \$    6,262,600

**REGION A  
OPERATION AND MAINTENANCE COSTS**

Line Work	22,000
Tanks	-0-
Pump Stations	10,000
Power Cost	195,000
Labor	111,000
Chemicals	<u>45,300</u>
	\$    383,300/Year

Appendix C-4

REGION B  
PRELIMINARY ESTIMATE OF TOTAL PROJECT COST

14" LINE	41,300 LF @ \$14/LF	578,200
12" LINE	24,300 LF @ \$12/LF	291,600
10" LINE	55,900 LF @ \$10/LF	559,000
Poteet Booster Station 2-2500 gpm pumps	2 @ 25,000/Ea	50,000
Pleasanton Booster Station 2-2400 gpm pumps	2 @ 30,000/Ea	60,000
Jourdanton Booster Station 2-2100 gpm pumps	2 @ 25,000/Ea	50,000
Charlotte Booster Station 2-900 gpm pumps	2 @ 15,000/Ea	<u>30,000</u>
	Subtotal Construction Cost	\$ 1,618,800
Contingencies		243,000
Engineering		162,000
Surveying		122,000
Geotechnical		20,000
Inspection		100,000
Land Acquisition		100,000
Legal and Fiscal		<u>59,000</u>
	Subtotal	806,000
	Total Project Cost	\$ 2,424,800

REGION B  
OPERATION AND MAINTENANCE COSTS

Line Work	7,100
Tanks	-0-
Pump Stations	9,500
Power Cost	170,000
Labor	111,000
Chemicals	<u>39,400</u>
	\$ 337,000/Year

Appendix C-5

REGION C  
PRELIMINARY ESTIMATE OF TOTAL PROJECT COST

12" LINE	40,000 LF @ 12/LF	481,200
16" LINE	74,200 LF @ 16/LF	1,187,200
12" LINE	82,300 LF @ 12/LF	987,600
8" LINE	20,100 LF @ 8/LF	160,800
Devine Booster Station 2-1600 gpm pumps	2 @ 20,000/Ea	40,000
Pearsall Booster Station 2-1600 gpm pumps	2 @ 20,000/Ea	40,000
Dilley Booster Station 2-1600 gpm pumps	2 @ 20,000/Ea	<u>40,000</u>
Subtotal Construction Cost		\$ 2,936,800
Contingencies		441,000
Engineering		235,000
Surveying		217,000
Geotechnical		20,000
Inspection		100,000
Land Acquisition		100,000
Legal and Fiscal		<u>101,000</u>
Subtotal		1,214,000
Total Project Cost		4,150,800

REGION C  
OPERATIONS AND MAINTENANCE COSTS

Line Work	14,100	
Tanks	-0-	
Pump Stations	6,000	
Power Cost	110,000	
Labor	111,000	
Chemicals	<u>25,600</u>	
		\$ 266,700/Year

**APPENDIX D**

**WATER CONSERVATION AND  
EMERGENCY WATER DEMAND MANAGEMENT PLAN**

WATER CONSERVATION AND EMERGENCY WATER  
DEMAND MANAGEMENT PLAN FOR PARTICIPATING  
MUNICIPALITIES IN ATASCOSA, FRIO,  
KARNES AND WILSON COUNTIES

**Introduction**

This document was prepared to complement the regional water plan developed for municipalities in Atascosa, Frio, Karnes and Wilson Counties, a study funded through a grant from the Texas Water Development Board. The participating municipalities involved in this study are Falls City, Floresville, Karnes City, Kenedy, Pearsall, Pleasanton, and Runge.

Water conservation represents an additional source of water. A reduction in water would allow the cities to continue to provide economical water service to more citizens and a dollar savings. Resource planners estimate that common-sense conservation efforts can result in a 10 to 15 percent water use reduction.

Though the study did not indicate an urgent need to institute conservation practices, for smaller rural communities implementation of such a plan would be very cost effective because of the limited financial resources of these. A water conservation and emergency water demand management plan would also be required if the entity were to apply for future construction funds from the Texas Water Development Board.

One major source of wasted water comes from leaks in underground distribution systems. Nationwide, unseen leaks account for an estimated 40 percent water loss rate. It may be necessary that leak detection specialists be brought in to help the municipalities locate these hidden water wasters.

Outdated plumbing fixtures are also substantial wasters of water. Design improvements in toilets, showerheads, and faucet fixtures allow appliances to use less than half of the water used by their older counterparts. The state has actively been encouraging the adoption of municipal ordinances requiring the use of ultra-low-flow (ULF) plumbing fixtures in new construction. These plumbing fixture requirements will be outlined further in the water conservation plan.

Generally, all of the water systems have limitations on its capabilities to divert, treat, sort and distribute water to its customers. To preserve the health and safety of the citizens, the cities intend to limit or curtail water use during droughts to levels within the available supply and the system capabilities.

Because each of the participating municipalities' water systems are serviced and operated individually, it would be necessary that each individual entity develop and implement its own

**Water Conservation and Emergency Water Demand Management Plan. Each plan will include much of the same information and will differ only in its rate structure and scope of jurisdiction. Included in this document is a Water Conservation and an Emergency Water Demand Management Plan, as well as a model resolution and ordinance that can be used to formally adopt the plan.**

# **WATER CONSERVATION PLAN**



## **Water Conservation Plan**

### **A. Education and Information**

One of the most important factors affecting how people use water is how well they understand the nature and characteristics of the resource itself. A well-informed citizenry will be more responsive and better equipped to meet the challenges facing them with respect to resource management. Because of this belief the municipalities will conduct a comprehensive public information and education program targeting children, adults and a variety of other groups and organizations. Fostering a water conservation ethic among present and future users is the cornerstone of the municipality's conservation effort.

The municipality's in school education program will target the special needs of teachers and students alike. The education program includes teacher workshops, in-service education, high quality audio-visual materials, multi-level curricula and resource materials, and possible theatrical presentations.

Information programs include a speaker's bureau, field trips, free standing displays for use in libraries, banks, malls and other public spaces, a seasonally-intensive conservation effort, water conservation materials, a variety of community outreach programs and a quarterly newsletter distributed to all customers four times during the first year of the program and twice per year thereafter. Regular articles will be published in the local paper at time intervals corresponding to the educational activities and more often if conditions warrant. New customers will receive general conservation information when applying for service.

Brochures and pamphlets prepared by the Texas Water Development Board (TWDB), the city and other relevant entities will be used. The public information program will include but not be limited to the following topics: (1) purpose and goals of the Water Conservation and Drought Contingency Plan; (2) the economic benefit of reduced water bills to customers; (3) benefit to customers due to the improvement of water facilities; (4) indoor water conservation techniques; and (5) general methods for conserving water.

### **B. Water Service Agreement**

The cities will adopt a policy whereby prospective customers enter and execute a written agreement which will include the following:

(1) Prospective customers must agree to follow the provisions of the respective Water Conservation and Drought Contingency Plan.

(2) Prospective customers must have in place at the time water service is initiated, the following water conserving plumbing fixtures:

Fixture	Standard
Shower Heads	No more than 2.75 gallons per minute at 80 pounds per square inch of pressure.
Lavatory/Sink Faucets and Aerators	No more than 2.2 gallons per minute at 60 pounds per square inch of pressure.
Wall Mounted, Flushometer Toilets	No more than 2.0 gallons per flush.
All Other Toilets	No more than 1.6 gallons per flush.
Urinals	No more than 1.0 gallons per flush.
Drinking Water Fountains	Must be self-closing.

In addition, prospective customers are required to insulate hot water pipes and install pressure reduction valves where system pressures exceed 80 pounds per square inch.

(3) Prospective commercial or industrial customers must have in place, at the time water service is initiated, such water conserving water fixtures as deemed appropriate by the City Administrator, including, but not limited to: (a) tank type toilets which limit water use to three and one-half gallons or flush type toilets which limit water use to three gallons; (b) tank type urinals which limit water use to three gallons or flush type urinals which limit water use to one gallon; (c) shower heads which limit water use to three gallons per minute when the system pressure is sixty pounds per square inch and; (d) aerators on all kitchen and bathroom faucets which limit water use to two and three-fourths gallons per minute when the system pressure is sixty pounds per square inch.

(4) Prospective customers who have swimming pools must have recirculating filtration equipment for the pool when water service is initiated.

(5) Prospective resale customers must adopt and implement the provisions of the City's Water Conservation and Drought Contingency Plan or develop and implement a similar plan which is acceptable to the City and approved by the TWDB.

#### C. Retrofit Program

The previously outlined public education program will include information for plumbers and customers to use when purchasing and installing plumbing fixtures, lawn watering equipment or water using appliances. Local retail outlets will be asked to stock water saving devices and water conservation kits.

#### D. Water Rate Structures

The City shall develop a water conservation rate structure to encourage the wise and efficient use of water and to discourage the peak demands placed on a water distribution system by lawn

watering and various other summer uses. In many residential communities well over half of the system capacity is dedicated to meeting peak demand. The City will not adopt declining water rate structures so as not to encourage the waste of water.

#### **E. Metering**

The City will ensure that all water users are metered, including city parks, city owned green and open space areas, and the city cemetery. The City will implement the following regularly scheduled maintenance and testing program of meter repair and replacement.

- (1) Production Meters - test once a year;
- (2) Meters larger than 1 1/2" - test once a year; and
- (3) Meters 1 1/2" and smaller - test every ten years

#### **F. Water Conserving Landscaping**

The public education program will include information and suggestions on water conserving landscaping (Xeriscape) and irrigation procedures which will reduce water usage and save money. Some methods outlined by the TWDB to be considered include:

- (1) establishing regulations for new subdivisions that require developers, landscape architects, contractors, and homeowners to use only adapted low water-using plants and grasses and efficient irrigation systems for landscaping new homes and facilities;
- (2) initiating a Xeriscape program that demonstrates the use of adapted, low water-using plants and grasses;
- (3) encouraging or requiring licensed irrigation contractors to design all irrigation systems with water conservation features, such as sprinklers that emit large drops rather than a fine mist, soil moisture monitoring, rain shut-off controls, and a sprinkler layout that accommodates prevailing wind direction;
- (4) encouraging or requiring commercial establishments to use drip irrigation for landscape water when possible and to install only ornamental fountains that recycle and use the minimum amount of water;
- (5) encouraging or requiring nurseries and local businesses to offer adapted, low water-using plants and grasses and efficient landscape watering devices, such as drip irrigation systems;
- (6) establishing landscape water audit programs, demonstration gardens and related programs; and
- (7) practicing other outdoor conservation practices such as covering pools and spas to reduce

evaporation when not in use, water harvesting where practical, using grey water or treated municipal effluent for irrigation where possible, and installing native or "permaculture" landscapes where applicable.

#### G. Leak Detection and Repair

The City will implement a leak detection, location and repair program to enhance water conservation efforts. The program will include:

- (1) identification through billing records of high water use and notifying customers of potential water leaks;
- (2) monthly comparison of total water sales and production;
- (3) continuous monitoring of reservoirs to detect water main breaks;
- (4) monitoring for unaccounted-for water sources such as fire hydrants, abandoned services, unmetered water used for fire-fighting or other uses and illegal hook-ups;
- (5) visual inspection by meter readers and city employees for abnormal conditions (i.e. leaks); and
- (6) prompt repair of water system leaks and water main breaks.

#### H. Recycling and Reuse

The city shall develop a recycling and reuse program to increase water supply in the service area. A method can be developed to reuse and recycle much of the effluent from the City's wastewater treatment plant. A municipal system or agricultural return flows can also be used to irrigate public open space around the city.

#### I. Excessive Pressure

According to the TWDB, pressure is the force which determines how much water can pass through a given faucet, valve, pipe or hole in a given time. The City shall develop a plan to monitor for excessive pressure in distribution system and provide information on methods of reducing the problem of excessive pressure.

#### J. Implementation and Enforcement

Except as provided by the Water Service Agreement, compliance with the City's water conservation program will be voluntary. User charges for water systems differ depending on the city and can be substantial in comparison to the relatively low median family income found in many of the rural communities. Therefore, voluntary compliance with water conservation measures should be effective.

**J. Conservation Plan Annual Report**

The City will file an annual report with the Executive Administrator of the TWDB. The report will address the progress and effectiveness of the Water Conservation plan and will include: (1) public information which has been issued; (2) public response; (3) effectiveness of water conservation plan in reducing water use by providing consumption data; and (4) implementation progress and status of the City's water conservation program.

**L. Wholesale Customers**

The City provides water services to some incorporated communities however, this service is provided directly to the user. The proposed Water Service Agreement will apply to resale customers and requires that such customers adopt and implement the provisions of the City's Water Conservation and Drought Contingency plan or develop and implement a similar plan which is acceptable to the City and approved by the TWDB.

EMERGENCY WATER DEMAND  
MANAGEMENT PLAN

## **Emergency Water Demand Management Plan**

### **A. Emergency Water Demand Conditions and Management Measures**

#### **1. Mild Conditions**

Mild emergency water demand conditions and management measures will be in effect when the daily water use equals or exceeds 85% of treatment capacity for seven consecutive days.

Under mild conditions, the citizens will be asked to restrict outside water use to specified time periods on assigned days and to otherwise conserve water. Compliance with mild condition management measures will be enforced by discontinuation of water service after warnings have been given.

#### **2. Moderate Conditions**

Moderate emergency water demand conditions and management measures will be in effect when the daily water use equals or exceeds 95% of treatment capacity for seven consecutive days and/or reservoir levels continually recede on a daily basis and remain below 75% of storage capacity for forty-eight consecutive hours and/or water pressures below 20 pounds per square inch (psi) occur in the distribution system.

Under moderate conditions, citizens will be required to restrict outside water use to specified time periods on assigned days, to repair all water leaks and to otherwise conserve water.

Compliance with outside water use restrictions and water leak provisions will be enforceable by discontinuation of water service after warnings have been given. Compliance with other water conservation measures will be voluntary.

#### **3. Severe Conditions or System Limitations**

Severe emergency water demand or system limitations conditions will be in effect when daily water use equals or exceeds 120% of treatment capacity for three consecutive days, and/or the reservoir levels continually recede on a daily basis and remain below 50% of storage capacity for twenty-four consecutive hours, and/or water pressures below 20 psi occur in the distribution system, and the City Administrator determines that such conditions are a hazard to the public health and safety. Severe emergency water demand or system limitations conditions will be in effect upon the failure of any system component which limits the treatment, storage or distribution capabilities of the system and the City Administrator determines that such conditions are a hazard to public health and safety.

Severe emergency water demand or system limitations conditions will be in effect upon the occurrence of limitations on the availability of raw water for prolonged periods and the City Administrator determines that such conditions are a hazard to public health and safety.

Under severe emergency water demand or system limitations conditions, outside water use will not be permitted and citizens will be required to repair all water leaks and to otherwise conserve water.

Compliance with outside water use restrictions and water leak provisions will be enforceable through discontinuation of water service after warnings have been given. Compliance with other water conservation measures will be voluntary.

#### B. Information and Education for Implementation

Once an emergency water demand management plan has been adopted by City Council, in addition to the public notice requirements for city ordinances the public will be informed through a press release to the local newspaper and by an annual notice enclosed with utility statements. The notices will give a thorough description of the plan, the means of implementation and assignments for outside water use restrictions.

#### C. Initiation Procedures, Public Notification and Termination

The City Administrator will determine when emergency water demand conditions occur and when management measures are to be placed in effect and when such conditions and management measures are to be ended.

Notice of the City Administrator's determinations will be given to the local newspapers, radio stations, and television stations. The notice will be posted at City Hall. The initiation notice will include: (1) the drought or emergency water demand condition situation; (2) the water conservation and management measures which the citizens are requested to implement; (3) the water conservation and management measures which the citizens must implement; (4) assignments and times of day for outside water use; (5) suggestions for conserving water; (6) the means of enforcement; and (7) penalties.

#### D. Outside Water Use

The City Administrator will establish time periods and assigned days on which outside water use is to be restricted or prohibited. Among other considerations the City Administrator's determinations will be based on (1) severity of conditions and need to conserve water; (2) system limitations; (3) distribution of services; and (4) response to previous restrictions.

The restrictions on outside water use shall prohibit outside water use at least between the hours of 9:00 a.m. to 6:00 p.m. The restrictions on outside water use shall not permit more than approximately one-third of the customers to use water outside on any given day and shall be established to promote a uniform use pattern through the service area.

Outside water uses which will be restricted or prohibited are (1) lawn and garden watering; (2) car washing and (3) sidewalk, driveway and street washing.



**E. Enforcement**

Warnings will be issued for violations of outside water use and water leaks and enforced through discontinuation of water service if compliance to prior warnings are not observed.

In the event that water service is discontinued due to violation of the provisions of the City's Emergency Water Demand Management Plan, service will not be restored until the customer has paid all fees and has entered and executed the City's Water Service Agreement.

**F. Health and Safety Hardship**

When the City Administrator determines that compliance with the provisions of the Emergency Water Demand Management Plan would create a health or safety hazard or an unnecessary hardship, the City Administrator may modify or waive the provisions.

**G. Emergency Water Demand Management Plan Ordinance**

The emergency water demand management plan will be authorized by a city ordinance.

**APPENDIX A**

**A MODEL RESOLUTION  
ADOPTING A WATER CONSERVATION AND EMERGENCY  
WATER DEMAND MANAGEMENT PLAN**

WHEREAS, the City of \_\_\_\_\_ obtained financial assistance as a participant of a study to develop a regional water plan for municipalities in Atascosa, Frio, Karnes and Wilson Counties from the Texas Water Development Board; and

WHEREAS, to qualify for further such assistance it is incumbent on the City to adopt a Water Conservation Plan and an Emergency Water Demand Management Plan; and

WHEREAS, the City has furnished copies of such study, which has been reviewed by the engineers for the City, \_\_\_\_\_, and by the City Attorney,  
\_\_\_\_\_.

WHEREAS, it is the desire of the City to adopt said plans in connection with its request for financial assistance for its water system. NOW, THEREFORE;

BE IT RESOLVED BY THE CITY COUNCIL OF THE CITY OF \_\_\_\_\_, TEXAS:

1. That the City of \_\_\_\_\_ hereby adopts the Water Conservation Plan and Emergency Water Demand Management Plan attached hereto.

2. That the copies of said plans attached hereto are incorporated in this resolution and made a part hereof.

3. That this resolution shall take effect immediately.

PASSED AND APPROVED this \_\_\_\_\_ day of \_\_\_\_\_, 1994.

City of \_\_\_\_\_

\_\_\_\_\_  
MAYOR

ATTEST:

\_\_\_\_\_  
CITY SECRETARY

## APPENDIX B

### A MODEL ORDINANCE ENACTING AN EMERGENCY WATER DEMAND MANAGEMENT PLAN FOR THE CITY OF \_\_\_\_\_ AND ITS WATER CUSTOMERS IN AND OUT OF THE CITY AND PRESCRIBING SANCTIONS

WHEREAS, the City of \_\_\_\_\_ is seeking financial assistance from the Texas Water Development Board; and

WHEREAS, pursuant thereto the City has adopted by its resolution passed on the \_\_\_\_ day of \_\_\_\_\_, 1994, a Water Conservation Plan and an Emergency Water Demand Management Plan (copies of which were attached thereto and made a part thereof); and

WHEREAS, it is necessary that the City, by ordinance, enact an emergency water demand management plan; and

WHEREAS, a majority of the customers of the city owned water system live outside the city limits of the City of \_\_\_\_\_; NOW THEREFORE

BE IT ORDAINED BY THE CITY COUNCIL OF THE CITY OF \_\_\_\_\_, TEXAS:

1. Emergency Water Demand conditions, when in existence, shall be categorized as (a) mild conditions; (b) moderate conditions; or (c) severe conditions.

When an emergency water demand condition clearly exists the City Administrator shall give a written report to the City Council declaring such emergency water demand condition and its category and shall cause public notice thereof to be given by publication and a notice to be mailed to each water customer.

2. The City administrator shall promptly draw up emergency water demand management measures, rules and regulations defining each of the three categories of emergency water demand conditions in specific terms peculiarly applicable to the City of \_\_\_\_\_ water system, its capacity and usage.

Such rules and regulations shall conform to the City's adopted Water Conservation and Emergency Water Demand Management Plan.

A copy of such rules and regulations shall be transmitted to the City Commission for its approval, thereafter a copy shall be mailed to each water customer.

Such regulations shall provide for warning and a request for voluntary compliance with stated water regulation to be sent to each water customer after a declaration of a mild emergency water demand condition.

Such regulations shall impose specific mandatory limitations on water usage by various classes of customers with notice to each water customer after a declaration of a moderate emergency water demand condition.

Such regulations shall impose both stringent water use limitations and certain usage prohibitions (to be specifically spelled out in such regulation) by various classes of customers with notice to each water customer after a declaration of a severe emergency water demand condition .

3. Failure of a water customer to comply with regulations applicable shall result in the enforcement of the following sanctions:

a. Mild Condition

(1) Compliance with Mild Emergency Water Demand Condition management measures is voluntary.

b. Moderate Condition

(1) A notice for specific mandatory compliance shall be sent by mail.

(2) If such notice is disregarded for so long as five (5) days, a "final warning" shall be sent by mail giving the customer three (3) days to become fully compliant.

(3) Continued non-compliance after such "final warning" for three (3) days shall result in water service being cut-off to such customer without further notice. Such service shall not be restored without payment of all fees.

c. Severe Condition

(1) A combined notice for specific mandatory compliance and "final warning" shall be sent to the non-complying customer by mail, giving such customer only three (3) days to reach full compliance.

(2) Continued non-compliance after notice and final warning prescribed above shall result in immediate discontinuance and cut-off of water service to such customer. It shall not be restored without payment of all fees.

4. This ordinance shall take effect immediately after it has been published in full one time in a newspaper of general circulation in the City of \_\_\_\_\_.

5. The City Administrator shall promulgate the necessary rules and regulations required by this ordinance (to include restatement of the sanctions provided above) within thirty (30) days after the publication of this ordinance. Such regulations, after approval of the City Council shall be published in full one time in a newspaper of general circulation in the city.

PASSED AND APPROVED this the \_\_\_\_ day of \_\_\_\_\_, 1994.

CITY OF \_\_\_\_\_

\_\_\_\_\_  
MAYOR

ATTEST:

\_\_\_\_\_  
CITY SECRETARY